

 	Pagina 584	KELM ISO 6432 rondcilinders	 	Pagina 623	AIGNEP compactcilinders
 	Pagina 590	KELM Gen 1 ISO 15552 cilinders		Pagina 626	Flowregelaars
 	Pagina 592	KELM Gen 2 ISO 15552 cilinders	 	Pagina 632	AIGNEP elektropneumatische ventielen
 	Pagina 598	KELM compactcilinders	 	Pagina 633	AIGNEP luchtbediende ventielen
 	Pagina 601	KELM pneumatische grijpers	 	Pagina 634	AIGNEP handbediende ventielen
 	Pagina 602	KELM hand- & mechanisch bediende ventielen	 	Pagina 637	AIGNEP magneetventielen
 	Pagina 607	KELM luchtbediende ventielen	 	Pagina 638	AIRCOMP hand- & mechanisch bediende ventielen
 	Pagina 609	KELM elektrisch bediende ventielen	 	Pagina 642	AIRCOMP voetbediende ventielen
 	Pagina 612	KELM logic & specialist ventielen	 	Pagina 643	AIRCOMP luchtbediende ventielen
 	Pagina 616	AIGNEP ISO 6432 rondcilinders - standaard & RVS	 	Pagina 645	AIRCOMP elektropneumatische schuifventielen
 	Pagina 619	AIGNEP ISO 15552 cilinders	 	Pagina 648	Vacuümtechniek

ISO 6432 persluchtcilinder

Accessoires en bevestiging selectie

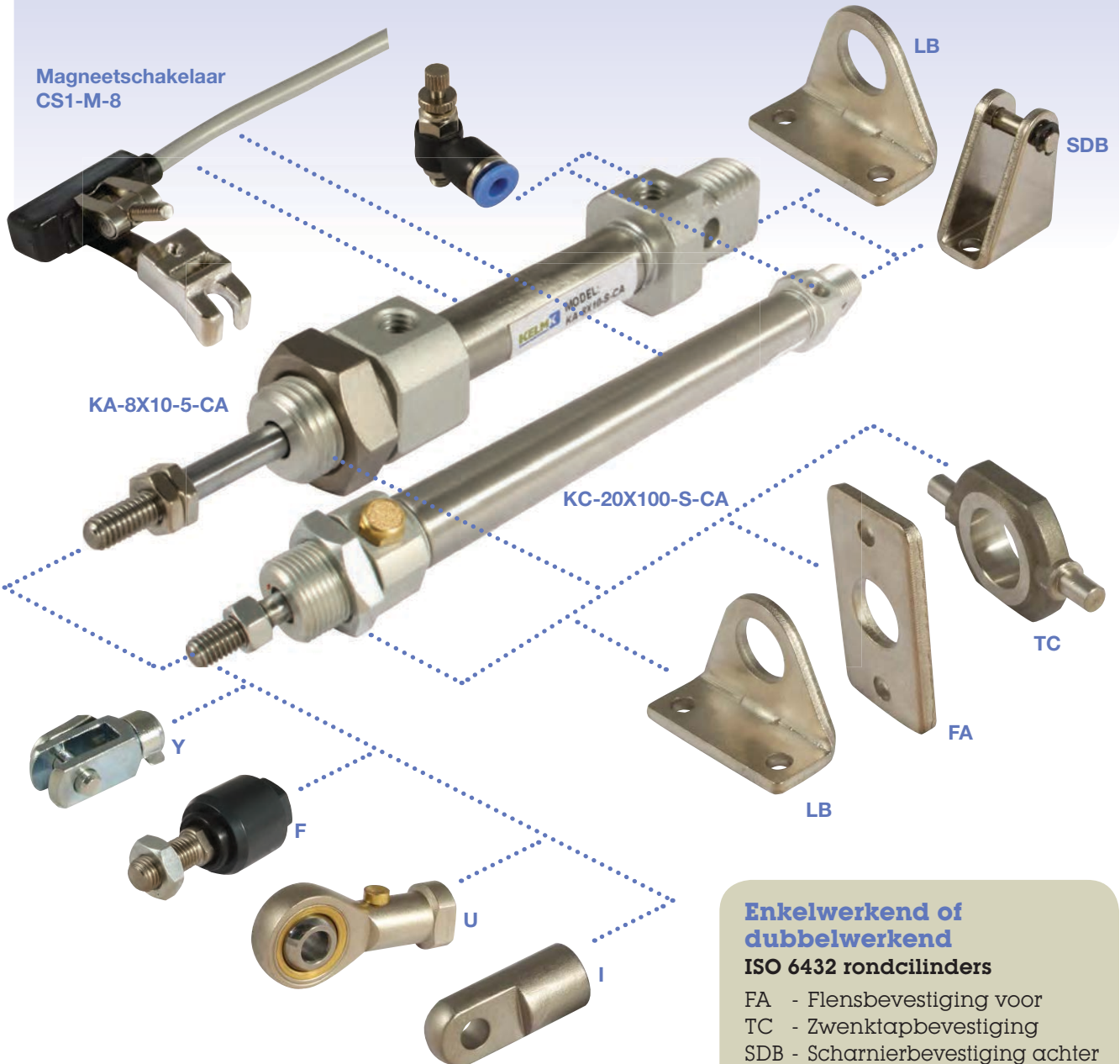

Enkelwerkend of dubbelwerkend

ISO 6432 rondcilinders

- FA - Flensbevestiging voor
 - TC - Zwenktapbevestiging
 - SDB - Scharnierbevestiging achter
 - LB - Bevestigingsvoet (paar)
 - Y - Zuigerstang gaffel
 - I - Zuigerstang gaffel
 - F - Uitlijnkop
 - U - Universele kogelstangkop
- Tweepolige magneetschakelaars
N/O met LED

ISO 6432 persluchtcilinder Technische informatie



KA serie

CA type

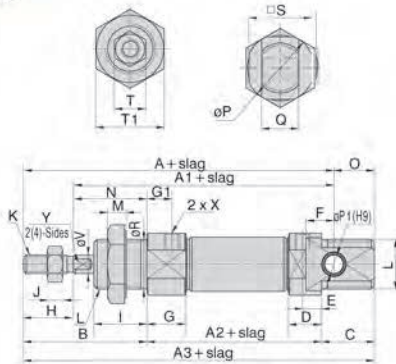

Boring	A	A1	A2	A3	A4	A5	A6	B	C	C1	C2	D	E	F	G	G1	H	I		
8	76	64	46	86	74	-	-	28	12	9.5	5	9.5	5	6	11.5	7	12	12		
10	76	64	46	86	74	-	-	28	12	9.5	5	9.5	5	6	11.5	7	12	12		
12	91	75	50	105	88	-	-	38	17	10.5	6	10.5	6	9	12.5	8	16	17		
16	98	82	56	111	94	111	94	38	17	10.5	6	10.5	6	9	12.5	8	16	17		
20	115	95	62	126	106	126	106	44	20	14.5	7.5	14.5	7.5	12	14.5	7.5	20	20		
25	126	104	65	137	114.5	137	115	50	22	16	8	16	8	12	16	8	22	22		
32	-	-	-	-	-	-	-	125	140	126	58	14	16.5	9	-	-	16.5	9	20	30
40	-	-	-	-	-	158	174	158	69	16	22	12	-	-	-	22	12	24	35	

Boring	J	K	L	M	N	O	P	P1	Q	R	S	T	T1	X	V	W	Y
8	2.5	M4 x 0.7	M12 x 1.25	6	16	10	17	4	8	12	15	7	17	M5 x 0.8	4	-	-
10	2.5	M4 x 0.7	M12 x 1.25	6	16	10	17	4	8	12	15	7	17	M5 x 0.8	4	-	-
12	5	M6 x 1.0	M16 x 1.5	6	22	14	20	6	12	16	18	10	22	M5 x 0.8	6	-	5
16	5	M6 x 1.0	M16 x 1.5	6	22	13	22	6	12	16	20	10	22	M5 x 0.8	6	13.5	5
20	6	M8 x 1.25	M22 x 1.5	7	24	11	29	8	16	22	25	12	29	1/8"	8	16.5	6
25	6	M10 x 1.25	M22 x 1.5	7	28	11	33.5	8	16	22	30	17	29	1/8"	10	18.5	8
32	6	M10 x 1.25	M30 x 1.5	7	38	-	37.5	-	30	34.5	17	36	1/8"	12	10.5	10	10
40	7	M12 x 1.25	M38 x 1.5	8	45	-	46.5	-	38	42.5	17	46	1/4"	16	12.5	14	14

KB serie

ø16 - ø25

Boring	A	A1	A2	A3	A4	A5	B	C	D
16	98	82	56	111	94	111	38	17	12.1
20	115	95	62	126	106	126	44	20	14.5
25	126	104	65	137	113.5	137	50	22	16

Boring	D1	D2	D3	E	F	G	G1	G2
16	7	9	12.1	6	9	12.5	7.5	9.5
20	7.5	10.5	14.5	8	12	14.5	7.5	10.5
25	8	10.5	14.5	8	12	16	8	12

Boring	H	I	J	K	L	M	O	N
16	16	17	5	M6 x 1.0	M16 x 1.5	6	13	22
20	20	20	6	M8 x 1.25	M22 x 1.5	7	11	24
25	22	22	6	M10 x 1.25	M22 x 1.5	7	11	28

Boring	P	Q	R	S	T	T1	V	W	X
16	22	12	5	20	10	22	6	13.5	M5 x 0.8
20	29	16	6	25	12	29	8	16.5	1/8"
25	33.5	16	9	30	17	29	10	18.5	1/8"

ø32, ø40

Boring	A2	A4	A5	B	C	D	D1	D2	D3	D4
32	68	124	140	58	14	16.5	9	11.5	14.5	7.5
40	89	157.5	174	69	16	22	12	12	21.5	11.5

Boring	D5	G	G1	G2	H	I	J	K
32	11	16.5	9	11.8	20	30	6	M10 x 1.25
40	14	22	12	12	24	35	7	M12 x 1.25

Boring	L	M	N	P	S	T	T1	V	W	X
32	M30 x 1.5	7	38	37.5	34.5	17	36	12	10.5	1/8"
40	M38 x 1.5	8	45	46.5	42.5	17	46	16	12.5	1/4"

KC serie

CA type

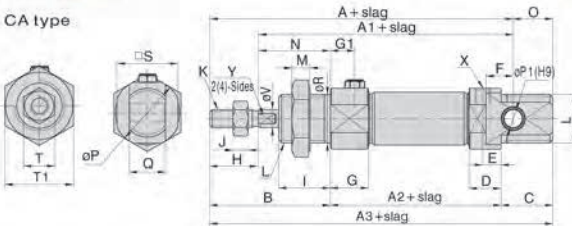

Binnenstructuur



Nr	Omschrijving	Materiaal
1	Slag	Stal
2	Zuigringman	Kunststof
3	Pakking kap voorzijde	NBR
4	Moer kap voorzijde	Kunststof
5	Omsluit	Slijvast metaal
6	Kap voorzijde	Aluminiumlegering
7	Bus	Stal
8	Buffer	TPU
9	Zuiger	303 Aluminiumlegering
10	Omsluit zuiger	NBR
11	Slijm	Slijvast metaal
12	Moer	Kunststof
13	Kap achterzijde	Aluminiumlegering

CM type

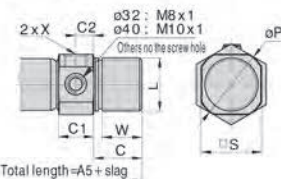

Boring	A			A1		
	0-50	51-100	101-150	0-50	51-100	101-150
8	101	-	-	89	-	-
10	101	-	-	89	-	-
12	116	-	-	100	-	-
16	123	148	-	107	132	-
20	140	165	190	120	145	170
25	151	176	201	129	154	179
32	-	-	-	-	-	-
40	-	-	-	-	-	-

Boring	A4			A5		
	0-50	51-100	101-150	0-50	51-100	101-150
8	99	-	-	-	-	-
10	99	-	-	-	-	-
12	113	-	-	-	-	-
16	119	144	-	136	161	-
20	131	156	181	151	176	201
25	139.5	164.5	189.5	162	187	212
32	150	175	200	165	190	215
40	183	208	233	199	224	249

Boring	A2			A3		
	0-50	51-100	101-150	0-50	51-100	101-150
8	71	-	-	111	-	-
10	71	-	-	111	-	-
12	75	-	-	130	-	-
16	81	106	-	136	161	-
20	87	112	137	151	176	201
25	90	115	140	162	187	212
32	-	-	-	-	-	-
40	-	-	-	-	-	-

Boring	A6			
	0-50	51-100	101-150	B C C1 C2
8	-	-	-	28 12 9.5 5
10	-	-	-	28 12 9.5 5
12	-	-	-	38 17 10.5 6
16	119	144	-	38 17 10.5 6
20	131	156	181	44 20 14.5 7.5
25	140	165	190	50 22 16 8
32	151	176	201	58 14 16.5 9
40	183	208	233	69 16 22 12

ISO 6432 rondcilinders

Werktemperatuur:
-20°C tot +70°C

Werkdruk:
2 tot 10 bar

**STANDAARD MET RVS
ZUIGERSTANG EN BUIS**

Medium:

Geconditioneerde perslucht, gefilterd (40µm) en gesmeerd.

Met kunststof buffers

Volledige technische specificaties worden op aanvraag verstrekt

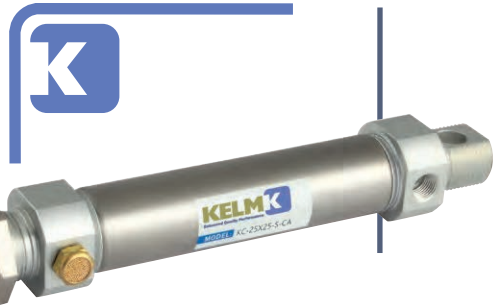
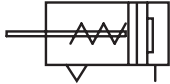

Magnetisch - enkelwerkend

0334					€	
KC-8X10-S-CA	8	10	M5	M12 x 1,25	M4 x 0,7	31.70
KC-8X15-S-CA	8	15	M5	M12 x 1,25	M4 x 0,7	31.70
KC-8X20-S-CA	8	20	M5	M12 x 1,25	M4 x 0,7	31.70
KC-8X25-S-CA	8	25	M5	M12 x 1,25	M4 x 0,7	31.70
KC-8X30-S-CA	8	30	M5	M12 x 1,25	M4 x 0,7	32.90
KC-8X40-S-CA	8	40	M5	M12 x 1,25	M4 x 0,7	32.90
KC-8X50-S-CA	8	50	M5	M12 x 1,25	M4 x 0,7	32.90
KC-10X10-S-CA	10	10	M5	M12 x 1,25	M4 x 0,7	32.90
KC-10X15-S-CA	10	15	M5	M12 x 1,25	M4 x 0,7	32.90
KC-10X20-S-CA	10	20	M5	M12 x 1,25	M4 x 0,7	32.90
KC-10X25-S-CA	10	25	M5	M12 x 1,25	M4 x 0,7	32.90
KC-10X30-S-CA	10	30	M5	M12 x 1,25	M4 x 0,7	34.75
KC-10X40-S-CA	10	40	M5	M12 x 1,25	M4 x 0,7	34.75
KC-10X50-S-CA	10	50	M5	M12 x 1,25	M4 x 0,7	34.75
KC-12X10-S-CA	12	10	M5	M16 x 1,5	M6 x 1,0	38.45
KC-12X15-S-CA	12	15	M5	M16 x 1,5	M6 x 1,0	38.45
KC-12X20-S-CA	12	20	M5	M16 x 1,5	M6 x 1,0	38.45
KC-12X25-S-CA	12	25	M5	M16 x 1,5	M6 x 1,0	38.45
KC-12X30-S-CA	12	30	M5	M16 x 1,5	M6 x 1,0	40.40
KC-12X40-S-CA	12	40	M5	M16 x 1,5	M6 x 1,0	40.40
KC-12X50-S-CA	12	50	M5	M16 x 1,5	M6 x 1,0	40.40
KC-16X10-S-CA	16	10	M5	M16 x 1,5	M6 x 1,0	45.40
KC-16X15-S-CA	16	15	M5	M16 x 1,5	M6 x 1,0	47.40
KC-16X20-S-CA	16	20	M5	M16 x 1,5	M6 x 1,0	47.40
KC-16X25-S-CA	16	25	M5	M16 x 1,5	M6 x 1,0	47.40
KC-16X30-S-CA	16	30	M5	M16 x 1,5	M6 x 1,0	48.95
KC-16X40-S-CA	16	40	M5	M16 x 1,5	M6 x 1,0	50.60
KC-16X50-S-CA	16	50	M5	M16 x 1,5	M6 x 1,0	50.60
KC-16X60-S-CA	16	60	M5	M16 x 1,5	M6 x 1,0	52.20
KC-16X75-S-CA	16	75	M5	M16 x 1,5	M6 x 1,0	52.20
KC-16X80-S-CA	16	80	M5	M16 x 1,5	M6 x 1,0	55.40
KC-16X100-S-CA	16	100	M5	M16 x 1,5	M6 x 1,0	55.40
KC-20X10-S-CA	20	10	1/8"	M22 x 1,5	M8 x 1,25	52.15
KC-20X15-S-CA	20	15	1/8"	M22 x 1,5	M8 x 1,25	52.15
KC-20X20-S-CA	20	20	1/8"	M22 x 1,5	M8 x 1,25	54.55
KC-20X25-S-CA	20	25	1/8"	M22 x 1,5	M8 x 1,25	54.55
KC-20X30-S-CA	20	30	1/8"	M22 x 1,5	M8 x 1,25	55.20
KC-20X40-S-CA	20	40	1/8"	M22 x 1,5	M8 x 1,25	55.20
KC-20X50-S-CA	20	50	1/8"	M22 x 1,5	M8 x 1,25	55.20
KC-20X60-S-CA	20	60	1/8"	M22 x 1,5	M8 x 1,25	58.65
KC-20X75-S-CA	20	75	1/8"	M22 x 1,5	M8 x 1,25	58.65
KC-20X80-S-CA	20	80	1/8"	M22 x 1,5	M8 x 1,25	63.80

0334					€	
KC-20X100-S-CA	20	100	1/8"	M22 x 1,5	M8 x 1,25	63.80
KC-20X125-S-CA	20	125	1/8"	M22 x 1,5	M8 x 1,25	65.20
KC-20X150-S-CA	20	150	1/8"	M22 x 1,5	M8 x 1,25	68.25
KC-25X10-S-CA	25	10	1/8"	M22 x 1,5	M10 x 1,25	59.05
KC-25X15-S-CA	25	15	1/8"	M22 x 1,5	M10 x 1,25	59.05
KC-25X20-S-CA	25	20	1/8"	M22 x 1,5	M10 x 1,25	59.05
KC-25X25-S-CA	25	25	1/8"	M22 x 1,5	M10 x 1,25	59.05
KC-25X30-S-CA	25	30	1/8"	M22 x 1,5	M10 x 1,25	63.55
KC-25X40-S-CA	25	40	1/8"	M22 x 1,5	M10 x 1,25	63.55
KC-25X50-S-CA	25	50	1/8"	M22 x 1,5	M10 x 1,25	63.55
KC-25X60-S-CA	25	60	1/8"	M22 x 1,5	M10 x 1,25	66.70
KC-25X75-S-CA	25	75	1/8"	M22 x 1,5	M10 x 1,25	66.70
KC-25X80-S-CA	25	80	1/8"	M22 x 1,5	M10 x 1,25	72.40
KC-25X100-S-CA	25	100	1/8"	M22 x 1,5	M10 x 1,25	72.40
KC-25X125-S-CA	25	125	1/8"	M22 x 1,5	M10 x 1,25	72.75
KC-25X150-S-CA	25	150	1/8"	M22 x 1,5	M10 x 1,25	76.25
KC-32X10-S-CM	32	10	1/8"	M30 x 1,5	M10 x 1,25	80.25
KC-32X15-S-CM	32	15	1/8"	M30 x 1,5	M10 x 1,25	80.25
KC-32X20-S-CM	32	20	1/8"	M30 x 1,5	M10 x 1,25	80.25
KC-32X25-S-CM	32	25	1/8"	M30 x 1,5	M10 x 1,25	80.25
KC-32X30-S-CM	32	30	1/8"	M30 x 1,5	M10 x 1,25	85.80
KC-32X40-S-CM	32	40	1/8"	M30 x 1,5	M10 x 1,25	85.80
KC-32X50-S-CM	32	50	1/8"	M30 x 1,5	M10 x 1,25	85.80
KC-32X60-S-CM	32	60	1/8"	M30 x 1,5	M10 x 1,25	91.60
KC-32X75-S-CM	32	75	1/8"	M30 x 1,5	M10 x 1,25	91.60
KC-32X80-S-CM	32	80	1/8"	M30 x 1,5	M10 x 1,25	97.10
KC-32X100-S-CM	32	100	1/8"	M30 x 1,5	M10 x 1,25	97.10
KC-32X125-S-CM	32	125	1/8"	M30 x 1,5	M10 x 1,25	102.65
KC-32X150-S-CM	32	150	1/8"	M30 x 1,5	M10 x 1,25	108.05
KC-40X10-S-CM	40	10	1/4"	M38 x 1,5	M12 x 1,25	97.40
KC-40X15-S-CM	40	15	1/4"	M38 x 1,5	M12 x 1,25	97.40
KC-40X20-S-CM	40	20	1/4"	M38 x 1,5	M12 x 1,25	97.40
KC-40X25-S-CM	40	25	1/4"	M38 x 1,5	M12 x 1,25	97.40
KC-40X30-S-CM	40	30	1/4"	M38 x 1,5	M12 x 1,25	104.40
KC-40X40-S-CM	40	40	1/4"	M38 x 1,5	M12 x 1,25	104.40
KC-40X50-S-CM	40	50	1/4"	M38 x 1,5	M12 x 1,25	104.40
KC-40X60-S-CM	40	60	1/4"	M38 x 1,5	M12 x 1,25	111.90
KC-40X75-S-CM	40	75	1/4"	M38 x 1,5	M12 x 1,25	111.90
KC-40X80-S-CM	40	80	1/4"	M38 x 1,5	M12 x 1,25	119.10
KC-40X100-S-CM	40	100	1/4"	M38 x 1,5	M12 x 1,25	119.10
KC-40X125-S-CM	40	125	1/4"	M38 x 1,5	M12 x 1,25	126.15
KC-40X150-S-CM	40	150	1/4"	M38 x 1,5	M12 x 1,25	133.55

- KELM™ pneumatiek
- Hydrauliek
- Snelkoppelingen
- Afsluiters
- Roestvast staal
- Fittingen
- Luchtconditionering
- Gereedschap
- Pneumatiek
- Diversen
- Malleabele fittingen & staal
- Ringleidingssystemen
- Slangen
- Compressoren

ISO 6432 rondcilinders

Werktemperatuur:
-20°C tot +70°C

Werkdruk:
1 tot 10 bar

**STANDAARD MET RVS
ZUIGERSTANG EN BUIS**



Medium:

Geconditioneerde perslucht, gefilterd (40µm) en gesmeerd.

Type KA: met kunststof buffers

Type KB: met instelbare buffering

Volledige technische specificaties worden op aanvraag verstrekt

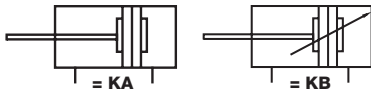

Magnetisch - dubbelwerkend

0334						
	mm	mm			€	
KA-8X10-S-CA	8	10	M5	M12 x 1,25	M4 x 0,7	26.90
KA-8X15-S-CA	8	15	M5	M12 x 1,25	M4 x 0,7	26.90
KA-8X20-S-CA	8	20	M5	M12 x 1,25	M4 x 0,7	26.90
KA-8X25-S-CA	8	25	M5	M12 x 1,25	M4 x 0,7	26.90
KA-8X30-S-CA	8	30	M5	M12 x 1,25	M4 x 0,7	28.05
KA-8X40-S-CA	8	40	M5	M12 x 1,25	M4 x 0,7	28.05
KA-8X50-S-CA	8	50	M5	M12 x 1,25	M4 x 0,7	28.05
KA-8X60-S-CA	8	60	M5	M12 x 1,25	M4 x 0,7	29.10
KA-8X75-S-CA	8	75	M5	M12 x 1,25	M4 x 0,7	29.10
KA-8X80-S-CA	8	80	M5	M12 x 1,25	M4 x 0,7	30.40
KA-8X100-S-CA	8	100	M5	M12 x 1,25	M4 x 0,7	30.40
KA-8X125-S-CA	8	125	M5	M12 x 1,25	M4 x 0,7	31.80
KA-8X150-S-CA	8	150	M5	M12 x 1,25	M4 x 0,7	33.15
KA-10X10-S-CA	10	10	M5	M12 x 1,25	M4 x 0,7	28.05
KA-10X15-S-CA	10	15	M5	M12 x 1,25	M4 x 0,7	28.05
KA-10X20-S-CA	10	20	M5	M12 x 1,25	M4 x 0,7	28.05
KA-10X25-S-CA	10	25	M5	M12 x 1,25	M4 x 0,7	28.05
KA-10X30-S-CA	10	30	M5	M12 x 1,25	M4 x 0,7	29.25
KA-10X40-S-CA	10	40	M5	M12 x 1,25	M4 x 0,7	29.25
KA-10X50-S-CA	10	50	M5	M12 x 1,25	M4 x 0,7	29.25
KA-10X60-S-CA	10	60	M5	M12 x 1,25	M4 x 0,7	31.25
KA-10X75-S-CA	10	75	M5	M12 x 1,25	M4 x 0,7	31.25
KA-10X80-S-CA	10	80	M5	M12 x 1,25	M4 x 0,7	32.70
KA-10X100-S-CA	10	100	M5	M12 x 1,25	M4 x 0,7	32.70
KA-10X125-S-CA	10	125	M5	M12 x 1,25	M4 x 0,7	34.80
KA-10X150-S-CA	10	150	M5	M12 x 1,25	M4 x 0,7	36.70
KA-10X160-S-CA	10	160	M5	M12 x 1,25	M4 x 0,7	38.30
KA-10X175-S-CA	10	175	M5	M12 x 1,25	M4 x 0,7	38.30
KA-10X200-S-CA	10	200	M5	M12 x 1,25	M4 x 0,7	40.20
KA-12X10-S-CA	12	10	M5	M16 x 1,5	M6 x 1,0	33.00
KA-12X15-S-CA	12	15	M5	M16 x 1,5	M6 x 1,0	33.00
KA-12X20-S-CA	12	20	M5	M16 x 1,5	M6 x 1,0	33.00
KA-12X25-S-CA	12	25	M5	M16 x 1,5	M6 x 1,0	33.70
KA-12X30-S-CA	12	30	M5	M16 x 1,5	M6 x 1,0	34.55
KA-12X40-S-CA	12	40	M5	M16 x 1,5	M6 x 1,0	34.55
KA-12X50-S-CA	12	50	M5	M16 x 1,5	M6 x 1,0	34.55
KA-12X60-S-CA	12	60	M5	M16 x 1,5	M6 x 1,0	36.70
KA-12X75-S-CA	12	75	M5	M16 x 1,5	M6 x 1,0	36.70
KA-12X80-S-CA	12	80	M5	M16 x 1,5	M6 x 1,0	38.30
KA-12X100-S-CA	12	100	M5	M16 x 1,5	M6 x 1,0	38.30
KA-12X125-S-CA	12	125	M5	M16 x 1,5	M6 x 1,0	39.80
KA-12X150-S-CA	12	150	M5	M16 x 1,5	M6 x 1,0	42.40
KA-12X160-S-CA	12	160	M5	M16 x 1,5	M6 x 1,0	45.70
KA-12X175-S-CA	12	175	M5	M16 x 1,5	M6 x 1,0	45.70
KA-12X200-S-CA	12	200	M5	M16 x 1,5	M6 x 1,0	46.30
KA-12X250-S-CA	12	250	M5	M16 x 1,5	M6 x 1,0	50.70
KB-16X10-S-CA	16	10	M5	M16 x 1,5	M6 x 1,0	53.10
KB-16X15-S-CA	16	15	M5	M16 x 1,5	M6 x 1,0	53.10
KB-16X20-S-CA	16	20	M5	M16 x 1,5	M6 x 1,0	53.10
KB-16X25-S-CA	16	25	M5	M16 x 1,5	M6 x 1,0	53.10

Raadpleeg de volgende pagina voor andere maten in deze reeks

0334						
	mm	mm			€	
KB-16X30-S-CA	16	30	M5	M16 x 1,5	M6 x 1,0	55.50
KB-16X40-S-CA	16	40	M5	M16 x 1,5	M6 x 1,0	55.50
KB-16X50-S-CA	16	50	M5	M16 x 1,5	M6 x 1,0	57.75
KB-16X60-S-CA	16	60	M5	M16 x 1,5	M6 x 1,0	57.75
KB-16X75-S-CA	16	75	M5	M16 x 1,5	M6 x 1,0	57.75
KB-16X80-S-CA	16	80	M5	M16 x 1,5	M6 x 1,0	61.30
KB-16X100-S-CA	16	100	M5	M16 x 1,5	M6 x 1,0	61.30
KB-16X125-S-CA	16	125	M5	M16 x 1,5	M6 x 1,0	61.00
KB-16X150-S-CA	16	150	M5	M16 x 1,5	M6 x 1,0	66.10
KB-16X160-S-CA	16	160	M5	M16 x 1,5	M6 x 1,0	67.55
KB-16X175-S-CA	16	175	M5	M16 x 1,5	M6 x 1,0	67.55
KB-16X200-S-CA	16	200	M5	M16 x 1,5	M6 x 1,0	67.95
KB-16X250-S-CA	16	250	M5	M16 x 1,5	M6 x 1,0	73.50
KB-16X300-S-CA	16	300	M5	M16 x 1,5	M6 x 1,0	78.45
KB-20X10-S-CA	20	10	1/8"	M22 x 1,5	M8 x 1,25	59.35
KB-20X15-S-CA	20	15	1/8"	M22 x 1,5	M8 x 1,25	59.35
KB-20X20-S-CA	20	20	1/8"	M22 x 1,5	M8 x 1,25	59.35
KB-20X25-S-CA	20	25	1/8"	M22 x 1,5	M8 x 1,25	60.80
KB-20X30-S-CA	20	30	1/8"	M22 x 1,5	M8 x 1,25	63.60
KB-20X40-S-CA	20	40	1/8"	M22 x 1,5	M8 x 1,25	63.60
KB-20X50-S-CA	20	50	1/8"	M22 x 1,5	M8 x 1,25	63.60
KB-20X60-S-CA	20	60	1/8"	M22 x 1,5	M8 x 1,25	67.00
KB-20X75-S-CA	20	75	1/8"	M22 x 1,5	M8 x 1,25	67.00
KB-20X80-S-CA	20	80	1/8"	M22 x 1,5	M8 x 1,25	67.00
KB-20X100-S-CA	20	100	1/8"	M22 x 1,5	M8 x 1,25	69.50
KB-20X125-S-CA	20	125	1/8"	M22 x 1,5	M8 x 1,25	73.50
KB-20X150-S-CA	20	150	1/8"	M22 x 1,5	M8 x 1,25	73.50
KB-20X160-S-CA	20	160	1/8"	M22 x 1,5	M8 x 1,25	76.40
KB-20X175-S-CA	20	175	1/8"	M22 x 1,5	M8 x 1,25	76.40
KB-20X200-S-CA	20	200	1/8"	M22 x 1,5	M8 x 1,25	78.10
KB-20X250-S-CA	20	250	1/8"	M22 x 1,5	M8 x 1,25	85.15
KB-20X300-S-CA	20	300	1/8"	M22 x 1,5	M8 x 1,25	91.25
KB-20X350-S-CA	20	350	1/8"	M22 x 1,5	M8 x 1,25	99.15
KB-20X400-S-CA	20	400	1/8"	M22 x 1,5	M8 x 1,25	106.00
KB-20X450-S-CA	20	450	1/8"	M22 x 1,5	M8 x 1,25	113.00
KB-20X500-S-CA	20	500	1/8"	M22 x 1,5	M8 x 1,25	119.90
KB-25X10-S-CA	25	10	1/8"	M22 x 1,5	M10 x 1,25	66.15
KB-25X15-S-CA	25	15	1/8"	M22 x 1,5	M10 x 1,25	66.15
KB-25X20-S-CA	25	20	1/8"	M22 x 1,5	M10 x 1,25	66.15
KB-25X25-S-CA	25	25	1/8"	M22 x 1,5	M10 x 1,25	66.15
KB-25X30-S-CA	25	30	1/8"	M22 x 1,5	M10 x 1,25	71.05
KB-25X40-S-CA	25	40	1/8"	M22 x 1,5	M10 x 1,25	71.05
KB-25X50-S-CA	25	50	1/8"	M22 x 1,5	M10 x 1,25	72.40
KB-25X60-S-CA	25	60	1/8"	M22 x 1,5	M10 x 1,25	72.40
KB-25X75-S-CA	25	75	1/8"	M22 x 1,5	M10 x 1,25	75.65
KB-25X80-S-CA	25	80	1/8"	M22 x 1,5	M10 x 1,25	75.65
KB-25X100-S-CA	25	100	1/8"	M22 x 1,5	M10 x 1,25	75.90

KELMK™ pneumatiek
Hydrauliek
Snelkoppelingen
Afsluiters
Roestvast staal
Fittingen
Luchtconditionering
Gereedschap
Pneumatiek
Diversen
Malleabele fittingen & staal
Ringleidingssystemen
Slangen
Compressoren

Persluchtcilinders

ISO 6432 rondcilinders

Werktemperatuur:
-20°C tot +70°C

Werkdruk:
1 tot 10 bar

**STANDAARD MET RVS
ZUIGERSTANG EN BUIS**

Medium:

Geconditioneerde perslucht, gefilterd (40µm) en gesmeerd.

Type KA: met kunststof buffers

Type KB: met instelbare buffering

Volledige technische specificaties worden op aanvraag verstrekt

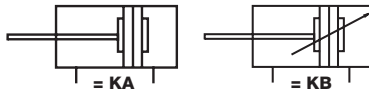

**Tech Data
3001**

Magnetisch - dubbelwerkend

0334	mm	mm	mm	A	Rod Thread	€
KB-25X125-S-CA	25	125	1/8"	M22 x 1,5	M10 x 1,25	80.75
KB-25X150-S-CA	25	150	1/8"	M22 x 1,5	M10 x 1,25	83.25
KB-25X160-S-CA	25	160	1/8"	M22 x 1,5	M10 x 1,25	87.75
KB-25X175-S-CA	25	175	1/8"	M22 x 1,5	M10 x 1,25	85.50
KB-25X200-S-CA	25	200	1/8"	M22 x 1,5	M10 x 1,25	91.15
KB-25X250-S-CA	25	250	1/8"	M22 x 1,5	M10 x 1,25	101.80
KB-25X300-S-CA	25	300	1/8"	M22 x 1,5	M10 x 1,25	101.50
KB-25X350-S-CA	25	350	1/8"	M22 x 1,5	M10 x 1,25	109.30
KB-25X400-S-CA	25	400	1/8"	M22 x 1,5	M10 x 1,25	113.55
KB-25X450-S-CA	25	450	1/8"	M22 x 1,5	M10 x 1,25	121.75
KB-25X500-S-CA	25	500	1/8"	M22 x 1,5	M10 x 1,25	132.90
KB-25X600-S-CA	25	600	1/8"	M22 x 1,5	M10 x 1,25	146.10
KB-32X10-S-CM	32	10	1/8"	M30 x 1,5	M10 x 1,25	87.80
KB-32X15-S-CM	32	15	1/8"	M30 x 1,5	M10 x 1,25	87.80
KB-32X20-S-CM	32	20	1/8"	M30 x 1,5	M10 x 1,25	87.80
KB-32X25-S-CM	32	25	1/8"	M30 x 1,5	M10 x 1,25	87.80
KB-32X30-S-CM	32	30	1/8"	M30 x 1,5	M10 x 1,25	92.55
KB-32X40-S-CM	32	40	1/8"	M30 x 1,5	M10 x 1,25	92.55
KB-32X50-S-CM	32	50	1/8"	M30 x 1,5	M10 x 1,25	92.55
KB-32X60-S-CM	32	60	1/8"	M30 x 1,5	M10 x 1,25	97.30
KB-32X75-S-CM	32	75	1/8"	M30 x 1,5	M10 x 1,25	97.30
KB-32X80-S-CM	32	80	1/8"	M30 x 1,5	M10 x 1,25	102.35
KB-32X100-S-CM	32	100	1/8"	M30 x 1,5	M10 x 1,25	102.35
KB-32X125-S-CM	32	125	1/8"	M30 x 1,5	M10 x 1,25	107.10
KB-32X150-S-CM	32	150	1/8"	M30 x 1,5	M10 x 1,25	111.90
KB-32X160-S-CM	32	160	1/8"	M30 x 1,5	M10 x 1,25	116.75
KB-32X175-S-CM	32	175	1/8"	M30 x 1,5	M10 x 1,25	116.75
KB-32X200-S-CM	32	200	1/8"	M30 x 1,5	M10 x 1,25	121.45
KB-32X250-S-CM	32	250	1/8"	M30 x 1,5	M10 x 1,25	130.90

0334	mm	mm	mm	A	Rod Thread	€
KB-32X300-S-CM	32	300	1/8"	M30 x 1,5	M10 x 1,25	141.25
KB-32X350-S-CM	32	350	1/8"	M30 x 1,5	M10 x 1,25	150.95
KB-32X400-S-CM	32	400	1/8"	M30 x 1,5	M10 x 1,25	161.40
KB-32X450-S-CM	32	450	1/8"	M30 x 1,5	M10 x 1,25	171.70
KB-32X500-S-CM	32	500	1/8"	M30 x 1,5	M10 x 1,25	182.00
KB-32X600-S-CM	32	600	1/8"	M30 x 1,5	M10 x 1,25	202.25
KB-40X10-S-CM	40	10	1/4"	M38 x 1,5	M12 x 1,25	104.25
KB-40X15-S-CM	40	15	1/4"	M38 x 1,5	M12 x 1,25	104.25
KB-40X20-S-CM	40	20	1/4"	M38 x 1,5	M12 x 1,25	104.25
KB-40X25-S-CM	40	25	1/4"	M38 x 1,5	M12 x 1,25	104.25
KB-40X30-S-CM	40	30	1/4"	M38 x 1,5	M12 x 1,25	110.75
KB-40X40-S-CM	40	40	1/4"	M38 x 1,5	M12 x 1,25	110.75
KB-40X50-S-CM	40	50	1/4"	M38 x 1,5	M12 x 1,25	110.75
KB-40X60-S-CM	40	60	1/4"	M38 x 1,5	M12 x 1,25	116.95
KB-40X75-S-CM	40	75	1/4"	M38 x 1,5	M12 x 1,25	116.95
KB-40X80-S-CM	40	80	1/4"	M38 x 1,5	M12 x 1,25	123.40
KB-40X100-S-CM	40	100	1/4"	M38 x 1,5	M12 x 1,25	123.40
KB-40X125-S-CM	40	125	1/4"	M38 x 1,5	M12 x 1,25	129.60
KB-40X150-S-CM	40	150	1/4"	M38 x 1,5	M12 x 1,25	134.95
KB-40X160-S-CM	40	160	1/4"	M38 x 1,5	M12 x 1,25	142.15
KB-40X175-S-CM	40	175	1/4"	M38 x 1,5	M12 x 1,25	142.15
KB-40X200-S-CM	40	200	1/4"	M38 x 1,5	M12 x 1,25	148.35
KB-40X250-S-CM	40	250	1/4"	M38 x 1,5	M12 x 1,25	167.45
KB-40X300-S-CM	40	300	1/4"	M38 x 1,5	M12 x 1,25	180.30
KB-40X350-S-CM	40	350	1/4"	M38 x 1,5	M12 x 1,25	193.45
KB-40X400-S-CM	40	400	1/4"	M38 x 1,5	M12 x 1,25	206.65
KB-40X450-S-CM	40	450	1/4"	M38 x 1,5	M12 x 1,25	219.90
KB-40X500-S-CM	40	500	1/4"	M38 x 1,5	M12 x 1,25	233.60
KB-40X600-S-CM	40	600	1/4"	M38 x 1,5	M12 x 1,25	260.55

ISO 6432 bevestigingen

**Tech Data
3002**



Flensbevestiging voor FA

0334	mm	€
F-KA8FA	8/10	1.80
F-KA12FA	12/16	1.95
F-KA20FA	20/25	2.75

**Tech Data
3003**



Zwenktapbevestiging voor TC

0334	mm	€
F-KA8TC	8/10	5.20
F-KA12TC	12/16	6.35
F-KA20TC	20/25	7.15
F-KA32TC	32	9.30
F-KA40TC	40	14.35

Persluchtcilinders

ISO 6432 bevestigingen

Tech Data
3004



Scharnierbevestiging achter SDB

0334	Ø mm	€
F-KA8SDB	8/10	3.90
F-KA12SDB	12/16	5.90
F-KA20SDB	20/25	6.35
F-KA32SDB	32	7.20
F-KA40SDB	40	8.00

Tech Data
3005



Bevestigingsvoet LB (paar)

0334	Ø mm	€
F-KA8LB	8/10	3.95
F-KA12LB	12/16	5.80
F-KA20LB	20/25	7.20
F-KA32LB	32	8.60
F-KA40LB	40	10.85

Tech Data
3006



Zuigerstang gaffel Y

0334	Ø mm	€	
F-M04070YE	8/10	M4 x 0,7	5.20
F-M06100YE	12/16	M6 x 1	7.20
F-M08125YE	20	M8 x 1,25	7.55
F-M1025YE	25/32	M10 x 1,25	9.55

Tech Data
3007



Zuigerstang gaffel I

0334	Ø mm	€	
F-M06100II	12/16	M6 x 1	5.20
F-M08125II	20	M8 x 1,25	5.65
F-M10125II	25/32	M10 x 1,25	7.00
F-M12125II	40	M12 x 1,25	9.25

Tech Data
3008



Uitlijnkop F

0334	Ø mm	€	
F-M08125F	20	M8 x 1,25	18.50
F-M10125F	25/32	M10 x 1,25	20.80
F-M12125F	40	M12 x 1,25	22.55

Tech Data
3009



Universele kogelstangkop U

0334	Ø mm	€	
F-M04070U	8/10	M4 x 0,7	8.65
F-M06100U	12/16	M6 x 1	8.85
F-M08125U	20	M8 x 1,25	8.95
F-M10125U	25/32	M10 x 1,25	10.95
F-M12125U	40	M12 x 1,25	12.85

ISO 6432 magneetschakelaars

Tech Data
3010



Tweepolig - NO met LED

0334	Ø mm	€	
CS1-M-8	8	5-240V AC/DC	23.40
CS1-M-10	10	5-240V AC/DC	23.40
CS1-M-12	12	5-240V AC/DC	23.40
CS1-M-16	16	5-240V AC/DC	23.40
CS1-M-20	20	5-240V AC/DC	23.40
CS1-M-25	25	5-240V AC/DC	23.40
CS1-M-32	32	5-240V AC/DC	23.40
CS1-M-40	40	5-240V AC/DC	23.40

KELM™
pneumatiek

Hydrauliek

Snel-
koppelingen

Afsluiters

Roestvast
staal

Fittingen

Lucht-
conditionering

Gereedschap

Pneumatiek

Diversen

Malleabele
fittingen
& staal

Ringleiding-
systemen

Slangen

Compressoren

Gen 1&2 ISO 15552 persluchtcilinder

Accessoires en bevestiging selectie

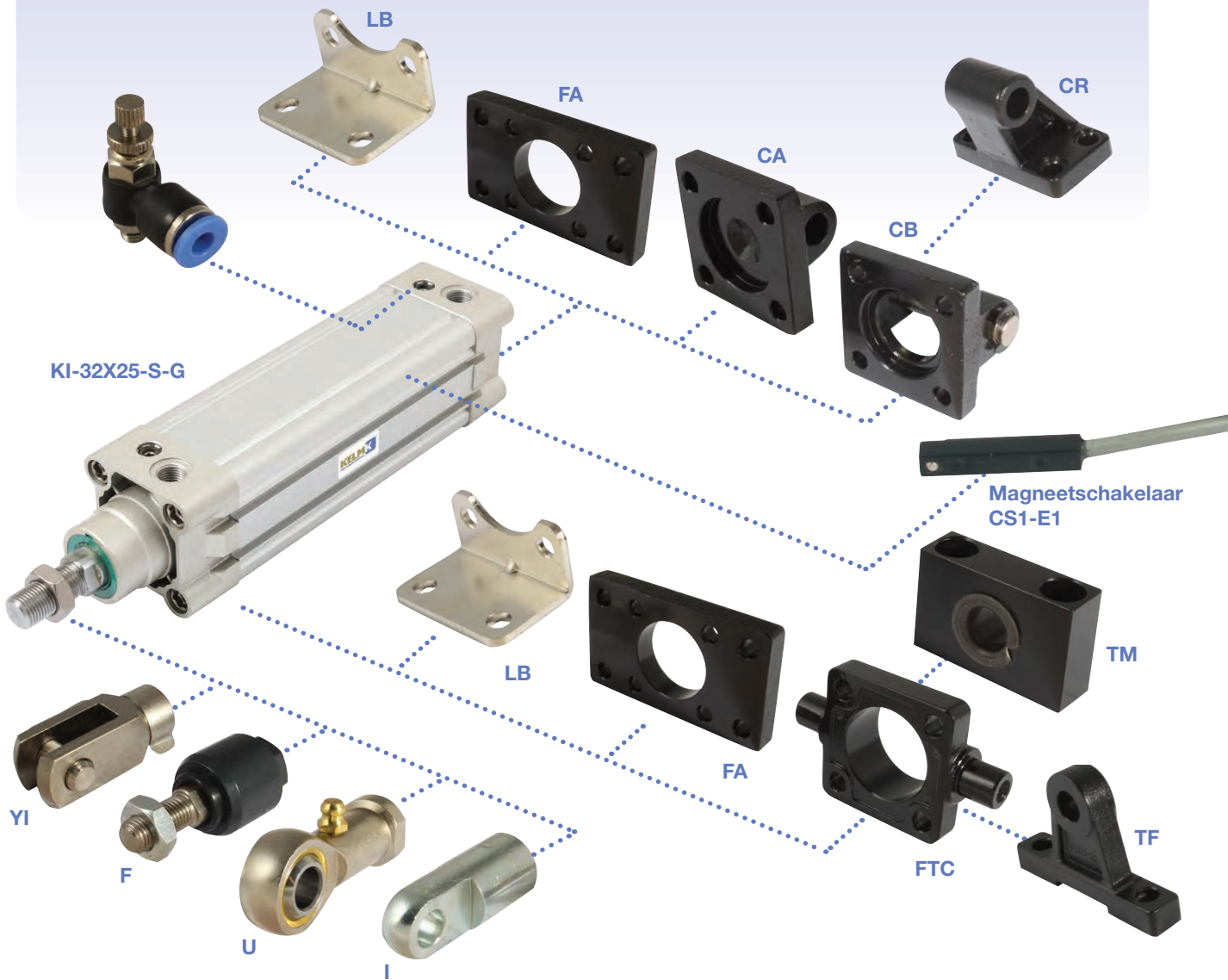

ISO 15552 cilinders

FA - Flensbevestiging voor/
achter
FTC - Zwenktapbevestiging voor
TF - Zwenktap/
gaffelbevestiging voor
TM - Zwenktapsteun
CA - Enkel achterscharnier
CB - Dubbel achterscharnier
CR - Bevestigingssteun achter

LB - Bevestigingsvoet (paar)
YI - Zuigerstang gaffel
I - Zuigerstang gaffel
F - Uitlijnkop
U - Universele kogelstangkop

Tweepolige magneetschakelaars
N/O met LED

Gen 1&2 ISO 1552 persluchtcilinder

Technische informatie

Binnenstructuur

Nr.	Onderdeel	Materiaal
1	Zuigerstangmoer	RVS
2	Zuigerstang	Gen 1: Koolstofstaal Gen 2: RVS
3	Pakking kap voorzijde	TPU
4	Kap voorzijde	Aluminiumlegering
5	Geleider	Slijtvast materiaal
6	O-ring buffer	TPU
7	Buis	Aluminiumlegering
8	O-ring	NBR
9	Zuiger	Aluminiumlegering
10	O-ring zuiger	TPU
11	Slijtring	Slijtvast materiaal
12	Magneet	Kunststof of rubber (rubber vanaf ø125)
13	Bout	Koolstofstaal
14	Buffer pakking	TPU
15	Kap achterzijde	Aluminiumlegering
16	Schroef	Koolstofstaal of RVS

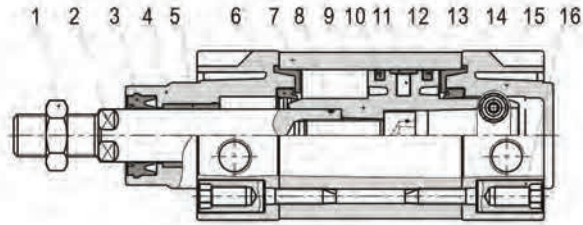

Afmetingen

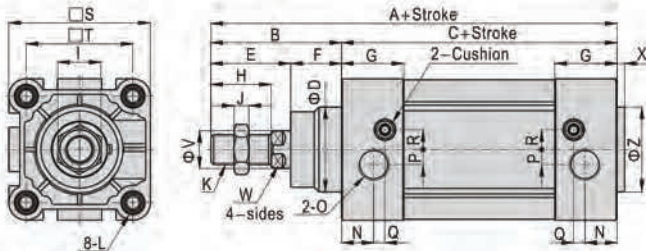

Boring	A	B	C	D	E	F	G	H	I	J	K	L	N	O	P	Q	R	S	T	V	W	X	Z
32	142	48	94	30	29	19	27.5	22	17	6	M10×1.25	M6	13.5	1/8"	5.8	6	6.3	46.5	32.5	12	10	3	30
40	159	54	105	35	33	21	32	24	17	7	M12×1.25	M6	17.5	1/4"	6	5.5	9	54	38	16	13	3.5	35
50	175	69	106	40	42	27	31	32	23	8	M16×1.5	M8	14	1/4"	8	5	10.5	64	46.5	20	17	3.5	40
63	190	69	121	45	42	27	33	32	23	8	M16×1.5	M8	17	3/8"	8	6	10.5	75	56.5	20	17	4	45
80	214	86	128	45	53	33	33	40	26	10	M20×1.5	M10	16.5	3/8"	8	8.5	12.5	93	72	25	22	4	45
100	229	91	138	55	55	36	37	40	26	10	M20×1.5	M10	19.5	1/2"	10	7	12	110	89	25	22	4	55
125	279	119	160	60	74	45	46	54	41	13.5	M27×2	M12	23	1/2"	11	12	11	134	110	32	27	4	60

Gen 1 ISO 15552 cilinders



Temperatuur: -20°C tot +80°C
Maximale werkdruk: 1 tot 10 bar

Medium:

Geconditioneerde perslucht, gefilterd (40µm) en gesmeerd.
Met instelbare buffering
Materiaal zuigerstang: Verchroomd koolstofstaal
Volledige technische specificaties worden op aanvraag verstrekt



KELM™
pneumatiek

Magnetisch - dubbelwerkend - instelbare buffering

	0414	Ø mm	Stroke mm	Stroke inch	Prod Thread	€
Hydrauliek	KI-32X25-S-G	32	25	1/8"	M10 x 1.25	58.50
	KI-32X50-S-G	32	50	1/8"	M10 x 1.25	61.05
	KI-32X75-S-G	32	75	1/8"	M10 x 1.25	63.60
Snelkoppelingen	KI-32X80-S-G	32	80	1/8"	M10 x 1.25	65.15
	KI-32X100-S-G	32	100	1/8"	M10 x 1.25	65.15
	KI-32X125-S-G	32	125	1/8"	M10 x 1.25	67.55
Afsluiters	KI-32X150-S-G	32	150	1/8"	M10 x 1.25	70.15
	KI-32X160-S-G	32	160	1/8"	M10 x 1.25	72.60
	KI-32X175-S-G	32	175	1/8"	M10 x 1.25	72.60
Roestvast staal	KI-32X200-S-G	32	200	1/8"	M10 x 1.25	74.70
	KI-32X250-S-G	32	250	1/8"	M10 x 1.25	79.45
	KI-32X300-S-G	32	300	1/8"	M10 x 1.25	84.00
Fittingen	KI-32X350-S-G	32	350	1/8"	M10 x 1.25	88.50
	KI-32X400-S-G	32	400	1/8"	M10 x 1.25	93.15
	KI-32X450-S-G	32	450	1/8"	M10 x 1.25	97.80
Luchtconditionering	KI-32X500-S-G	32	500	1/8"	M10 x 1.25	102.35
	KI-40X25-S-G	40	25	1/4"	M12 x 1.25	65.15
	KI-40X50-S-G	40	50	1/4"	M12 x 1.25	67.55
Gereedschap	KI-40X75-S-G	40	75	1/4"	M12 x 1.25	70.15
	KI-40X80-S-G	40	80	1/4"	M12 x 1.25	72.60
	KI-40X100-S-G	40	100	1/4"	M12 x 1.25	72.60
Pneumatiek	KI-40X125-S-G	40	125	1/4"	M12 x 1.25	75.15
	KI-50X25-S-G	50	25	1/4"	M16 x 1.5	80.15
	KI-50X50-S-G	50	50	1/4"	M16 x 1.5	82.75
Diversen	KI-50X75-S-G	50	75	1/4"	M16 x 1.5	85.40
	KI-50X80-S-G	50	80	1/4"	M16 x 1.5	87.75
	KI-50X100-S-G	50	100	1/4"	M16 x 1.5	87.75
Malleabele fittingen & staal	KI-50X125-S-G	50	125	1/4"	M16 x 1.5	91.65
	KI-50X150-S-G	50	150	1/4"	M16 x 1.5	95.30
	KI-50X160-S-G	50	160	1/4"	M16 x 1.5	99.05
Ringleidingssystemen	KI-50X175-S-G	50	175	1/4"	M16 x 1.5	99.05

	0414	Ø mm	Stroke mm	Stroke inch	Prod Thread	€
Hydrauliek	KI-40X150-S-G	40	150	1/4"	M12 x 1.25	77.60
	KI-40X160-S-G	40	160	1/4"	M12 x 1.25	79.95
	KI-40X175-S-G	40	175	1/4"	M12 x 1.25	79.95
Snelkoppelingen	KI-40X200-S-G	40	200	1/4"	M12 x 1.25	82.35
	KI-40X250-S-G	40	250	1/4"	M12 x 1.25	87.75
	KI-40X300-S-G	40	300	1/4"	M12 x 1.25	93.15
Afsluiters	KI-40X350-S-G	40	350	1/4"	M12 x 1.25	98.70
	KI-40X400-S-G	40	400	1/4"	M12 x 1.25	104.05
	KI-40X450-S-G	40	450	1/4"	M12 x 1.25	109.35
Roestvast staal	KI-40X500-S-G	40	500	1/4"	M12 x 1.25	115.00
	KI-40X600-S-G	40	600	1/4"	M12 x 1.25	126.10
	KI-40X700-S-G	40	700	1/4"	M12 x 1.25	137.15
Fittingen	KI-40X800-S-G	40	800	1/4"	M12 x 1.25	148.65
	KI-50X25-S-G	50	25	1/4"	M16 x 1.5	80.15
	KI-50X50-S-G	50	50	1/4"	M16 x 1.5	82.75
Luchtconditionering	KI-50X75-S-G	50	75	1/4"	M16 x 1.5	85.40
	KI-50X80-S-G	50	80	1/4"	M16 x 1.5	87.75
	KI-50X100-S-G	50	100	1/4"	M16 x 1.5	87.75
Gereedschap	KI-50X125-S-G	50	125	1/4"	M16 x 1.5	91.65
	KI-50X150-S-G	50	150	1/4"	M16 x 1.5	95.30
	KI-50X160-S-G	50	160	1/4"	M16 x 1.5	99.05
Pneumatiek	KI-50X175-S-G	50	175	1/4"	M16 x 1.5	99.05

Raadpleeg de volgende pagina voor andere maten in deze reeks

Gen 1 ISO 15552 cilinders

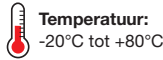

Temperatuur: -20°C tot +80°C
Maximale werkdruk: 1 tot 10 bar

Medium:

Geconditioneerde perslucht, gefilterd (40µm) en gesmeerd.
Met instelbare buffering
Materiaal zuigerstang: Verchroomd koolstofstaal
Volledige technische specificaties worden op aanvraag verstrekt



Magnetisch - dubbelwerkend - instelbare buffering

0414	Ø mm	mm	mm	Red Thread	€
KI-50X200-S-G	50	200	1/4"	M16 x 1.5	102.70
KI-50X250-S-G	50	250	1/4"	M16 x 1.5	109.25
KI-50X300-S-G	50	300	1/4"	M16 x 1.5	115.70
KI-50X350-S-G	50	350	1/4"	M16 x 1.5	122.55
KI-50X400-S-G	50	400	1/4"	M16 x 1.5	129.35
KI-50X450-S-G	50	450	1/4"	M16 x 1.5	136.20
KI-50X500-S-G	50	500	1/4"	M16 x 1.5	143.15
KI-50X600-S-G	50	600	1/4"	M16 x 1.5	156.95
KI-50X700-S-G	50	700	1/4"	M16 x 1.5	171.05
KI-50X800-S-G	50	800	1/4"	M16 x 1.5	185.00
KI-50X900-S-G	50	900	1/4"	M16 x 1.5	199.40
KI-50X1000-S-G	50	1000	1/4"	M16 x 1.5	213.80
KI-63X25-S-G	63	25	3/8"	M16 x 1.5	98.80
KI-63X50-S-G	63	50	3/8"	M16 x 1.5	102.85
KI-63X75-S-G	63	75	3/8"	M16 x 1.5	106.90
KI-63X80-S-G	63	80	3/8"	M16 x 1.5	112.20
KI-63X100-S-G	63	100	3/8"	M16 x 1.5	112.20
KI-63X125-S-G	63	125	3/8"	M16 x 1.5	115.70
KI-63X150-S-G	63	150	3/8"	M16 x 1.5	119.05
KI-63X160-S-G	63	160	3/8"	M16 x 1.5	122.85
KI-63X175-S-G	63	175	3/8"	M16 x 1.5	122.85
KI-63X200-S-G	63	200	3/8"	M16 x 1.5	126.80
KI-63X250-S-G	63	250	3/8"	M16 x 1.5	134.95
KI-63X300-S-G	63	300	3/8"	M16 x 1.5	142.90
KI-63X350-S-G	63	350	3/8"	M16 x 1.5	151.25
KI-63X400-S-G	63	400	3/8"	M16 x 1.5	159.35
KI-63X450-S-G	63	450	3/8"	M16 x 1.5	167.75
KI-63X500-S-G	63	500	3/8"	M16 x 1.5	176.80
KI-63X600-S-G	63	600	3/8"	M16 x 1.5	193.45
KI-63X700-S-G	63	700	3/8"	M16 x 1.5	210.65
KI-63X800-S-G	63	800	3/8"	M16 x 1.5	228.10
KI-63X900-S-G	63	900	3/8"	M16 x 1.5	245.65
KI-63X1000-S-G	63	1000	3/8"	M16 x 1.5	263.45
KI-80X25-S-G	80	25	3/8"	M20 x 1.5	132.75
KI-80X50-S-G	80	50	3/8"	M20 x 1.5	136.90
KI-80X75-S-G	80	75	3/8"	M20 x 1.5	142.20
KI-80X80-S-G	80	80	3/8"	M20 x 1.5	147.45
KI-80X100-S-G	80	100	3/8"	M20 x 1.5	147.45
KI-80X125-S-G	80	125	3/8"	M20 x 1.5	153.10
KI-80X150-S-G	80	150	3/8"	M20 x 1.5	159.00
KI-80X160-S-G	80	160	3/8"	M20 x 1.5	164.70
KI-80X175-S-G	80	175	3/8"	M20 x 1.5	164.70
KI-80X200-S-G	80	200	3/8"	M20 x 1.5	170.65
KI-80X250-S-G	80	250	3/8"	M20 x 1.5	182.30
KI-80X300-S-G	80	300	3/8"	M20 x 1.5	194.25
KI-80X350-S-G	80	350	3/8"	M20 x 1.5	206.00
KI-80X400-S-G	80	400	3/8"	M20 x 1.5	217.95
KI-80X450-S-G	80	450	3/8"	M20 x 1.5	229.85

0414	Ø mm	mm	mm	Red Thread	€
KI-80X500-S-G	80	500	3/8"	M20 x 1.5	241.80
KI-80X600-S-G	80	600	3/8"	M20 x 1.5	266.00
KI-80X700-S-G	80	700	3/8"	M20 x 1.5	290.80
KI-80X800-S-G	80	800	3/8"	M20 x 1.5	315.40
KI-80X900-S-G	80	900	3/8"	M20 x 1.5	340.55
KI-80X1000-S-G	80	1000	3/8"	M20 x 1.5	365.65
KI-100X25-S-G	100	25	1/2"	M20 x 1.5	164.35
KI-100X50-S-G	100	50	1/2"	M20 x 1.5	172.10
KI-100X75-S-G	100	75	1/2"	M20 x 1.5	179.35
KI-100X80-S-G	100	80	1/2"	M20 x 1.5	185.35
KI-100X100-S-G	100	100	1/2"	M20 x 1.5	185.35
KI-100X125-S-G	100	125	1/2"	M20 x 1.5	192.40
KI-100X150-S-G	100	150	1/2"	M20 x 1.5	199.40
KI-100X160-S-G	100	160	1/2"	M20 x 1.5	206.20
KI-100X175-S-G	100	175	1/2"	M20 x 1.5	206.20
KI-100X200-S-G	100	200	1/2"	M20 x 1.5	213.05
KI-100X250-S-G	100	250	1/2"	M20 x 1.5	226.80
KI-100X300-S-G	100	300	1/2"	M20 x 1.5	240.60
KI-100X350-S-G	100	350	1/2"	M20 x 1.5	254.50
KI-100X400-S-G	100	400	1/2"	M20 x 1.5	268.40
KI-100X450-S-G	100	450	1/2"	M20 x 1.5	282.50
KI-100X500-S-G	100	500	1/2"	M20 x 1.5	296.60
KI-100X600-S-G	100	600	1/2"	M20 x 1.5	324.90
KI-100X700-S-G	100	700	1/2"	M20 x 1.5	353.15
KI-100X800-S-G	100	800	1/2"	M20 x 1.5	382.00
KI-100X900-S-G	100	900	1/2"	M20 x 1.5	410.80
KI-100X1000-S-G	100	1000	1/2"	M20 x 1.5	440.00
KI-125X25-S-G	125	25	1/2"	M27 x 2	259.30
KI-125X50-S-G	125	50	1/2"	M27 x 2	267.25
KI-125X75-S-G	125	75	1/2"	M27 x 2	274.85
KI-125X80-S-G	125	80	1/2"	M27 x 2	282.80
KI-125X100-S-G	125	100	1/2"	M27 x 2	282.80
KI-125X125-S-G	125	125	1/2"	M27 x 2	294.55
KI-125X150-S-G	125	150	1/2"	M27 x 2	306.00
KI-125X160-S-G	125	160	1/2"	M27 x 2	317.10
KI-125X175-S-G	125	175	1/2"	M27 x 2	317.10
KI-125X200-S-G	125	200	1/2"	M27 x 2	328.15
KI-125X250-S-G	125	250	1/2"	M27 x 2	350.95
KI-125X300-S-G	125	300	1/2"	M27 x 2	373.60
KI-125X350-S-G	125	350	1/2"	M27 x 2	396.55
KI-125X400-S-G	125	400	1/2"	M27 x 2	419.45
KI-125X450-S-G	125	450	1/2"	M27 x 2	442.45
KI-125X500-S-G	125	500	1/2"	M27 x 2	465.30
KI-125X600-S-G	125	600	1/2"	M27 x 2	511.30
KI-125X700-S-G	125	700	1/2"	M27 x 2	557.35
KI-125X800-S-G	125	800	1/2"	M27 x 2	603.80
KI-125X900-S-G	125	900	1/2"	M27 x 2	650.90
KI-125X1000-S-G	125	1000	1/2"	M27 x 2	698.15

Gen 2 ISO 15552 cilinders



Temperatuur:
-20°C tot +80°C

Maximale
werkdruk:
1 tot 10 bar

RVS
ZUIGERSTANG



Medium:

Geconditioneerde perslucht, gefilterd (40µm) en gesmeerd.
Met instelbare buffering

Materiaal zuigerstang: RVS AISI-304

Volledige technische specificaties worden op aanvraag verstrekt

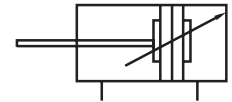

Magnetisch - dubbelwerkend - instelbare buffering

	0413	Ø mm	Stroke mm	Stroke inch	Prod Thread	€	0413	Ø mm	Stroke mm	Stroke inch	Prod Thread	€
Hydrauliek	KI-32BX25-S-G	32	25	1/8"	M10 x 1.25	72.65	KI-40BX150-S-G	40	150	1/4"	M12 x 1.25	96.35
	KI-32BX50-S-G	32	50	1/8"	M10 x 1.25	75.85	KI-40BX160-S-G	40	160	1/4"	M12 x 1.25	99.30
	KI-32BX75-S-G	32	75	1/8"	M10 x 1.25	79.05	KI-40BX175-S-G	40	175	1/4"	M12 x 1.25	99.30
Snel-koppelingen	KI-32BX80-S-G	32	80	1/8"	M10 x 1.25	80.85	KI-40BX200-S-G	40	200	1/4"	M12 x 1.25	102.30
	KI-32BX100-S-G	32	100	1/8"	M10 x 1.25	80.85	KI-40BX250-S-G	40	250	1/4"	M12 x 1.25	108.95
	KI-32BX125-S-G	32	125	1/8"	M10 x 1.25	83.90	KI-40BX300-S-G	40	300	1/4"	M12 x 1.25	115.60
Afsluiters	KI-32BX150-S-G	32	150	1/8"	M10 x 1.25	87.15	KI-40BX350-S-G	40	350	1/4"	M12 x 1.25	122.50
	KI-32BX160-S-G	32	160	1/8"	M10 x 1.25	90.05	KI-40BX400-S-G	40	400	1/4"	M12 x 1.25	129.20
	KI-32BX175-S-G	32	175	1/8"	M10 x 1.25	90.05	KI-40BX450-S-G	40	450	1/4"	M12 x 1.25	135.90
Roestvast staal	KI-32BX200-S-G	32	200	1/8"	M10 x 1.25	92.90	KI-40BX500-S-G	40	500	1/4"	M12 x 1.25	142.70
	KI-32BX250-S-G	32	250	1/8"	M10 x 1.25	98.65	KI-40BX600-S-G	40	600	1/4"	M12 x 1.25	156.55
	KI-32BX300-S-G	32	300	1/8"	M10 x 1.25	104.35	KI-40BX700-S-G	40	700	1/4"	M12 x 1.25	170.40
Fittingen	KI-32BX350-S-G	32	350	1/8"	M10 x 1.25	109.85	KI-40BX800-S-G	40	800	1/4"	M12 x 1.25	184.60
	KI-32BX400-S-G	32	400	1/8"	M10 x 1.25	115.60	KI-50BX25-S-G	50	25	1/4"	M16 x 1.5	99.55
	KI-32BX450-S-G	32	450	1/8"	M10 x 1.25	121.40	KI-50BX50-S-G	50	50	1/4"	M16 x 1.5	102.75
Lucht-conditionering	KI-32BX500-S-G	32	500	1/8"	M10 x 1.25	127.15	KI-50BX75-S-G	50	75	1/4"	M16 x 1.5	105.95
	KI-40BX25-S-G	40	25	1/4"	M12 x 1.25	80.85	KI-50BX80-S-G	50	80	1/4"	M16 x 1.5	108.95
	KI-40BX50-S-G	40	50	1/4"	M12 x 1.25	83.90	KI-50BX100-S-G	50	100	1/4"	M16 x 1.5	108.95
Gereedschap	KI-40BX75-S-G	40	75	1/4"	M12 x 1.25	87.15	KI-50BX125-S-G	50	125	1/4"	M16 x 1.5	113.75
	KI-40BX80-S-G	40	80	1/4"	M12 x 1.25	90.05	KI-50BX150-S-G	50	150	1/4"	M16 x 1.5	118.40
	KI-40BX100-S-G	40	100	1/4"	M12 x 1.25	90.05	KI-50BX160-S-G	50	160	1/4"	M16 x 1.5	122.95
Pneumatiek	KI-40BX125-S-G	40	125	1/4"	M12 x 1.25	93.35	KI-50BX175-S-G	50	175	1/4"	M16 x 1.5	122.95

Raadpleeg de volgende pagina voor andere maten in deze reeks

Gen 2 ISO 15552 cilinders



Temperatuur:
-20°C tot +80°C

**Maximale
werkdruk:**
1 tot 10 bar

**RVS
ZUIGERSTANG**

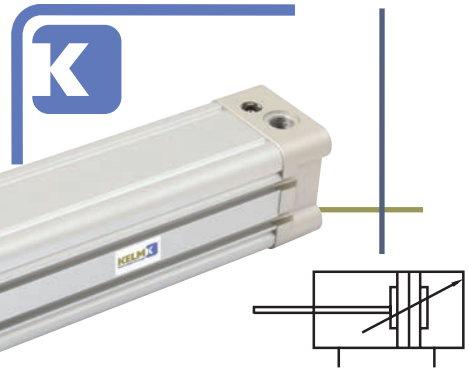

Medium:

Geconditioneerde perslucht, gefilterd (40µm) en gesmeerd.
Met instelbare buffering
Materiaal zuigerstang: RVS AISI-304
Volledige technische specificaties worden op aanvraag verstrekt

Magnetisch - dubbelwerkend - instelbare buffering

0413	Ø mm	Stroke mm	Stroke inch	Rod Thread	€	0413	Ø mm	Stroke mm	Stroke inch	Rod Thread	€
KI-50BX200-S-G	50	200	1/4"	M16 x 1.5	127.55	KI-80BX500-S-G	80	500	3/8"	M20 x 1.5	300.30
KI-50BX250-S-G	50	250	1/4"	M16 x 1.5	135.60	KI-80BX600-S-G	80	600	3/8"	M20 x 1.5	330.35
KI-50BX300-S-G	50	300	1/4"	M16 x 1.5	143.70	KI-80BX700-S-G	80	700	3/8"	M20 x 1.5	361.20
KI-50BX350-S-G	50	350	1/4"	M16 x 1.5	152.20	KI-80BX800-S-G	80	800	3/8"	M20 x 1.5	391.75
KI-50BX400-S-G	50	400	1/4"	M16 x 1.5	160.70	KI-80BX900-S-G	80	900	3/8"	M20 x 1.5	423.05
KI-50BX450-S-G	50	450	1/4"	M16 x 1.5	169.15	KI-80BX1000-S-G	80	1000	3/8"	M20 x 1.5	454.10
KI-50BX500-S-G	50	500	1/4"	M16 x 1.5	177.75	KI-100BX25-S-G	100	25	1/2"	M20 x 1.5	204.15
KI-50BX600-S-G	50	600	1/4"	M16 x 1.5	195.00	KI-100BX50-S-G	100	50	1/2"	M20 x 1.5	213.80
KI-50BX700-S-G	50	700	1/4"	M16 x 1.5	212.40	KI-100BX75-S-G	100	75	1/2"	M20 x 1.5	222.10
KI-50BX800-S-G	50	800	1/4"	M16 x 1.5	229.65	KI-100BX80-S-G	100	80	1/2"	M20 x 1.5	230.10
KI-50BX900-S-G	50	900	1/4"	M16 x 1.5	247.60	KI-100BX100-S-G	100	100	1/2"	M20 x 1.5	230.10
KI-50BX1000-S-G	50	1000	1/4"	M16 x 1.5	265.50	KI-100BX125-S-G	100	125	1/2"	M20 x 1.5	238.85
KI-63BX25-S-G	63	25	3/8"	M16 x 1.5	122.75	KI-100BX150-S-G	100	150	1/2"	M20 x 1.5	247.60
KI-63BX50-S-G	63	50	3/8"	M16 x 1.5	127.85	KI-100BX160-S-G	100	160	1/2"	M20 x 1.5	256.15
KI-63BX75-S-G	63	75	3/8"	M16 x 1.5	132.65	KI-100BX175-S-G	100	175	1/2"	M20 x 1.5	256.15
KI-63BX80-S-G	63	80	3/8"	M16 x 1.5	139.30	KI-100BX200-S-G	100	200	1/2"	M20 x 1.5	264.60
KI-63BX100-S-G	63	100	3/8"	M16 x 1.5	139.30	KI-100BX250-S-G	100	250	1/2"	M20 x 1.5	281.70
KI-63BX125-S-G	63	125	3/8"	M16 x 1.5	143.70	KI-100BX300-S-G	100	300	1/2"	M20 x 1.5	298.85
KI-63BX150-S-G	63	150	3/8"	M16 x 1.5	147.80	KI-100BX350-S-G	100	350	1/2"	M20 x 1.5	316.15
KI-63BX160-S-G	63	160	3/8"	M16 x 1.5	152.65	KI-100BX400-S-G	100	400	1/2"	M20 x 1.5	333.35
KI-63BX175-S-G	63	175	3/8"	M16 x 1.5	152.65	KI-100BX450-S-G	100	450	1/2"	M20 x 1.5	350.90
KI-63BX200-S-G	63	200	3/8"	M16 x 1.5	157.45	KI-100BX500-S-G	100	500	1/2"	M20 x 1.5	368.30
KI-63BX250-S-G	63	250	3/8"	M16 x 1.5	167.65	KI-100BX600-S-G	100	600	1/2"	M20 x 1.5	403.55
KI-63BX300-S-G	63	300	3/8"	M16 x 1.5	177.50	KI-100BX700-S-G	100	700	1/2"	M20 x 1.5	438.70
KI-63BX350-S-G	63	350	3/8"	M16 x 1.5	187.85	KI-100BX800-S-G	100	800	1/2"	M20 x 1.5	474.55
KI-63BX400-S-G	63	400	3/8"	M16 x 1.5	197.95	KI-100BX900-S-G	100	900	1/2"	M20 x 1.5	510.15
KI-63BX450-S-G	63	450	3/8"	M16 x 1.5	208.30	KI-100BX1000-S-G	100	1000	1/2"	M20 x 1.5	546.50
KI-63BX500-S-G	63	500	3/8"	M16 x 1.5	218.85	KI-125BX25-S-G	125	25	1/2"	M27 x 2	322.15
KI-63BX600-S-G	63	600	3/8"	M16 x 1.5	240.25	KI-125BX50-S-G	125	50	1/2"	M27 x 2	332.00
KI-63BX700-S-G	63	700	3/8"	M16 x 1.5	261.65	KI-125BX75-S-G	125	75	1/2"	M27 x 2	341.45
KI-63BX800-S-G	63	800	3/8"	M16 x 1.5	283.30	KI-125BX80-S-G	125	80	1/2"	M27 x 2	351.35
KI-63BX900-S-G	63	900	3/8"	M16 x 1.5	305.10	KI-125BX100-S-G	125	100	1/2"	M27 x 2	351.35
KI-63BX1000-S-G	63	1000	3/8"	M16 x 1.5	327.20	KI-125BX125-S-G	125	125	1/2"	M27 x 2	365.80
KI-80BX25-S-G	80	25	3/8"	M20 x 1.5	163.45	KI-125BX150-S-G	125	150	1/2"	M27 x 2	380.05
KI-80BX50-S-G	80	50	3/8"	M20 x 1.5	170.10	KI-125BX160-S-G	125	160	1/2"	M27 x 2	393.85
KI-80BX75-S-G	80	75	3/8"	M20 x 1.5	176.55	KI-125BX175-S-G	125	175	1/2"	M27 x 2	393.85
KI-80BX80-S-G	80	80	3/8"	M20 x 1.5	182.95	KI-125BX200-S-G	125	200	1/2"	M27 x 2	407.65
KI-80BX100-S-G	80	100	3/8"	M20 x 1.5	182.95	KI-125BX250-S-G	125	250	1/2"	M27 x 2	435.90
KI-80BX125-S-G	80	125	3/8"	M20 x 1.5	190.10	KI-125BX300-S-G	125	300	1/2"	M27 x 2	463.95
KI-80BX150-S-G	80	150	3/8"	M20 x 1.5	197.45	KI-125BX350-S-G	125	350	1/2"	M27 x 2	492.45
KI-80BX160-S-G	80	160	3/8"	M20 x 1.5	204.55	KI-125BX400-S-G	125	400	1/2"	M27 x 2	521.00
KI-80BX175-S-G	80	175	3/8"	M20 x 1.5	204.55	KI-125BX450-S-G	125	450	1/2"	M27 x 2	549.50
KI-80BX200-S-G	80	200	3/8"	M20 x 1.5	211.95	KI-125BX500-S-G	125	500	1/2"	M27 x 2	577.80
KI-80BX250-S-G	80	250	3/8"	M20 x 1.5	226.45	KI-125BX600-S-G	125	600	1/2"	M27 x 2	635.05
KI-80BX300-S-G	80	300	3/8"	M20 x 1.5	241.15	KI-125BX700-S-G	125	700	1/2"	M27 x 2	692.30
KI-80BX350-S-G	80	350	3/8"	M20 x 1.5	255.95	KI-125BX800-S-G	125	800	1/2"	M27 x 2	750.00
KI-80BX400-S-G	80	400	3/8"	M20 x 1.5	270.60	KI-125BX900-S-G	125	900	1/2"	M27 x 2	808.40
KI-80BX450-S-G	80	450	3/8"	M20 x 1.5	285.55	KI-125BX1000-S-G	125	1000	1/2"	M27 x 2	867.00

Persluchtcilinders

ISO 15552 bevestigingen

Tech Data
3012



Flensbevestiging voor/achter FA

0334	Ø mm	€
F-KF32FA	32	9.20
F-KF40FA	40	9.65
F-KF50FA	50	11.40
F-KF63FA	63	14.70
F-KF80FA	80	22.65
F-KF100FA	100	26.70
F-KF125FA	125	72.50
F-KF160FA	160	118.40
F-KF200FA	200	168.15

Tech Data
3013



Zwenktapbevestiging voor FTC

0334	Ø mm	€
F-KF32FTC	32	28.60
F-KF40FTC	40	28.95
F-KF50FTC	50	39.70
F-KF63FTC	63	47.05
F-KF80FTC	80	57.90
F-KF100FTC	100	93.10
F-KF125FTC	125	128.75
F-KF160FTC	160	224.60
F-KF200FTC	200	340.75

Tech Data
3014



Zwenktap/gaffelbevestiging voor TF

0334	Ø mm	€
F-KF32TF	32	17.65
F-KF40TF	40/50	28.60
F-KF63TF	63/80	50.05
F-KF125TF	100/125	116.05
F-KF160TF	160	207.75
F-KF200TF	200	250.80

Tech Data
3015



Zwenktapsteun TM

0334	Ø mm	€
F-KF32TM	32	14.30
F-KF40TM	40/50	17.65
F-KF63TM	63/80	25.00
F-KF125TM	100/125	35.55
F-KF160TM	160/200	51.50

Tech Data
3016



Enkel achterscharnier CA

0334	Ø mm	€
F-KF32CA	32	9.90
F-KF40CA	40	10.45
F-KF50CA	50	12.65
F-KF63CA	63	14.20
F-KF80CA	80	21.90
F-KF100CA	100	26.60
F-KF125CA	125	80.75
F-KF160CA	160	121.75
F-KF200CA	200	161.80

Tech Data
3017



Dubbel achterscharnier CB

0334	Ø mm	€
F-KF32CB	32	11.90
F-KF40CB	40	13.15
F-KF50CB	50	16.50
F-KF63CB	63	17.60
F-KF80CB	80	25.55
F-KF100CB	100	28.70
F-KF125CB	125	98.85
F-KF160CB	160	137.15
F-KF200CB	200	182.60

Tech Data
3018



Bevestigingssteun achter CR

0334	Ø mm	€
F-KF32CR	32	12.15
F-KF40CR	40	13.00
F-KF50CR	50	15.15
F-KF63CR	63	16.85
F-KF80CR	80	25.65
F-KF100CR	100	33.15
F-KF125CR	125	101.10
F-KF160CR	160	145.85
F-KF200CR	200	197.75

Tech Data
3019



Bevestigingsvoet LB (paar)

0334	Ø mm	€
F-KF32LB	32	6.35
F-KF40LB	40	7.05
F-KF50LB	50	7.80
F-KF63LB	63	9.55
F-KF80LB	80	10.55
F-KF100LB	100	12.15
F-KF125LB	125	48.75
F-KF160LB	160	76.05
F-KF200LB	200	108.65

Tech Data
3020



Zuigerstang gaffel YI

0334	Ø mm	€	
F-M10125YI	32	M10 x 1,25	9.55
F-M12125YI	40	M12 x 1,25	14.45
F-M16150YI	50/63	M16 x 1,5	22.80
F-M20150YI	80/100	M20 x 1,5	31.95
F-M27200YI	125	M27 x 2	47.65
F-M36200YI	160/200	M36 x 2	69.50

ISO 15552 bevestigingen

Tech Data
3021



Zuigerstang gaffel I

0334	Ø mm		€
F-M10125II	25/32	M10 x 1,25	7.00
F-M12125II	40	M12 x 1,25	9.25
F-M16150II	50/63	M16 x 1,5	13.55
F-M20150II	80/100	M20 x 1,5	23.15
F-M27200II	125	M27 x 2	31.50
F-M36200II	160/200	M36 x 2	50.70

Tech Data
3022



Uitlijnkop F

0334	Ø mm		€
F-M10125F	25/32	M10 x 1,25	20.80
F-M12125F	40	M12 x 1,25	22.55
F-M16150F	50/63	M16 x 1,5	40.50
F-M20150F	80/100	M20 x 1,5	58.70

Tech Data
3023



Universele kogelstangkop U

0334	Ø mm		€
F-M10125U	25/32	M10 x 1,25	10.95
F-M12125U	40	M12 x 1,25	12.85
F-M16150U	50/63	M16 x 1,5	22.90
F-M20150U	80/100	M20 x 1,5	36.55
F-M27200U	125	M27 x 2	70.15
F-M36200U	160/200	M36 x 2	106.05

Gen 1&2 ISO 15552 magneetschakelaars

Tech Data
20890



Tweepolig - NO met LED

0413	L m		€
CS1-E020	2	5-240V AC/DC	21.40
CS1-E050	5	5-240V AC/DC	25.50

ISO 15552 revisieset



Tech Data
20387

Standaard

0334	Ø	€
KFRK-32	32	9.45
KFRK-40	40	11.90
KFRK-50	50	14.25
KFRK-63	63	16.95
KFRK-80	80	21.50
KFRK-100	100	26.85
KFRK-125	125	33.40
KFRK-160	160	41.05
KFRK-200	200	50.10

KELM™
pneumatiek

Hydrauliek

Snel-
koppelingen

Afsluiters

Roestvast
staal

Fittingen

Lucht-
conditionering

Gereedschap

Pneumatiek

Diversen

Malleabele
fittingen
& staal

Ringleiding-
systemen

Slangen

Compressoren

Compacte persluchtcilinder

Accessoires en bevestiging selectie

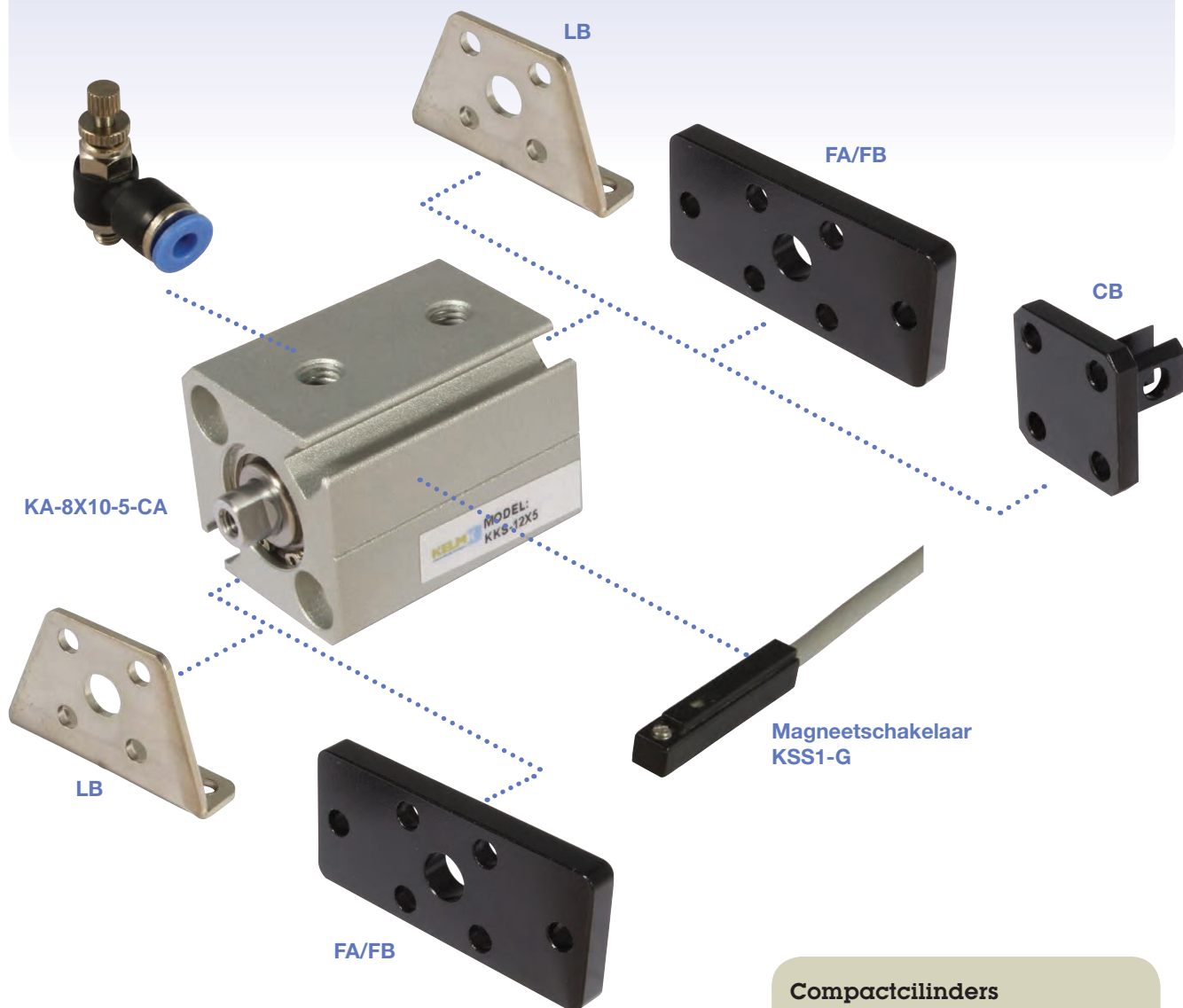

Compactcilinders

CB - Gaffelscharnier achter
FA/FB - Flensbevestiging voor/achter
LB - Bevestigingsvoet (paar)
Tweepolige magneetschakelaars
N/O met LED

Compacte persluchtcilinder

Technische informatie

KKS serie

Afmetingen

ø12 & ø16

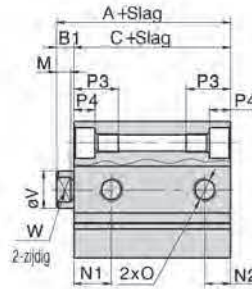
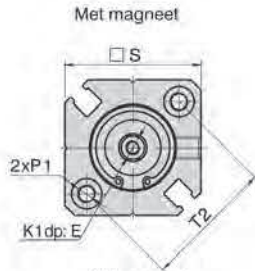

ø20 & ø25

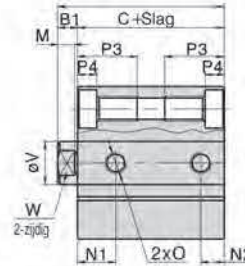
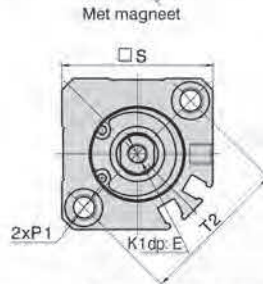

Model	Met magneet		B1	D	E	K1	M	N1		N2	
	Zonder magneet	Met magneet						Zonder magneet	Met magneet		
12	31.5	28	3.6	—	6	M3 x 0.5	3.5	7.5	9	5	7
16	34	30.5	2.6	—	8	M4 x 0.7	3	8	9.8	—	3.5
20	36	31.5	4.5	—	7	M5 x 0.8	4	9	9.5	—	5.5
25	37.5	32.5	5	25	12	M6 x 1.0	4.5	11	—	—	5.5

Boring	D	P1	P3	P4	S	T1	T2	V	W		
12	M3 x 0.5	2-zijdig ø6.5	Draad: M4 x 0.7	Gat: ø3.4	11	3.5	25	15.5	22	6	5
16	M3 x 0.5	2-zijdig ø6.3	Draad: M4 x 0.7	Gat: ø3.4	11	3.5	29	23	28	8	6
20	M5 x 0.8	2-zijdig ø9	Draad: M6 x 1.0	Gat: ø5.2	17	7	36	25.6	36	10	8
25	M6 x 0.8	2-zijdig ø9	Draad: M6 x 1.0	Gat: ø5.2	17	7	40	28	40	12	10

Afmetingen

ø32 to ø100
(Slag ≤ 100)

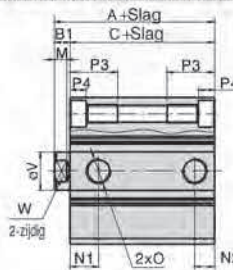
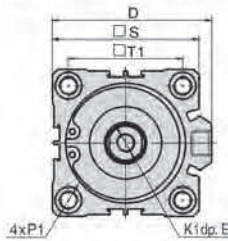

Model	Met magneet		B1	D	E	K1	M	N1		N2		
	Zonder magneet	Met magneet						Zonder magneet	Met magneet			
32	St-5	40	33	7	49.5	13	M8 x 1.25	6	7.5	10.5	6.5	7.5
	St-6	—	—	—	—	—	—	—	10.5	—	7.5	—
40	46.5	39.5	7	57	13	M8 x 1.25	6	11	—	8	—	—
50	St-5	48.5	40.5	8	71	15	M10 x 1.5	6.5	9	10.5	9	10.5
	St-6	—	—	—	—	—	—	—	10.5	—	10.5	—
63	St-5	54	46	8	84	15	M10 x 1.5	6.5	14	15	9.5	10.5
	St-6	—	—	—	—	—	—	—	15	—	10.5	—
80	63.5	53.5	10	104	20	M16 x 2.0	8.5	16	—	14	—	—
100	75	63	12	120.5	26	M20 x 2.5	9.5	20	—	17.5	—	—

Boring	D	P1	P3	P4	S	T1	T2	V	W		
32	1/8"	2-zijdig ø9	Draad: M6 x 1.0	Gat: ø5.2	17	7	45	34	—	18	14
40	1/8"	2-zijdig ø9	Draad: M6 x 1.0	Gat: ø5.2	17	7	53	40	—	16	14
50	1/4"	2-zijdig ø11	Draad: M8 x 1.25	Gat: ø6.5	22	8	64	50	—	20	17
63	1/4"	2-zijdig ø14	Draad: M10 x 1.5	Gat: ø8.7	28.5	10.5	77	60	—	20	17
80	3/8"	2-zijdig ø17.5	Draad: M12 x 1.75	Gat: ø10.7	35.5	13.5	98	77	—	25	22
100	3/8"	2-zijdig ø17.5	Draad: M12 x 1.75	Gat: ø10.7	35.5	13.5	117	94	—	32	27

Binnenstructuur

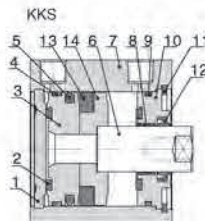

Nr.	Onderdeel	Materiaal
1	Kap achterzijde	12 & 16 Aluminiumlegging
2	Buffer	TPU NBR
3	Zuiger	Messing Aluminiumlegging
4	Slijtring	Slijvast materiaal
5	O-ring zuiger	NBR
6	Zuigerstang	Koolstofstaal 20µm verchroomd
7	Huis	Aluminiumlegging
8	Geleider	Slijvast materiaal
9	Kap pakking	NBR
10	Kap voorzijde	Messing Aluminiumlegging
11	C clip	Verenstaal
12	Pakking kap voorzijde	NBR
13	Magneet	Gesinterd metaal Plastic
14	Magneetrouder	Messing Aluminiumlegging

Persluchtcilinders

Tech Data 3027

Compactcilinders

Werktemperatuur:
-20°C tot +80°C

Werkdruk:
1 tot 10 bar

Medium:

Geconditioneerde perslucht, gefilterd (40µm) en gesmeerd.

Met kunststof buffers

Behuizing: aluminium

Afdichtingen: NBR

Volledige technische specificaties worden op aanvraag verstrekt

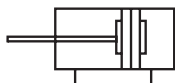

Magnetisch - dubbelwerkend

Raadpleeg de volgende pagina voor andere maten in deze reeks

0334					€
KKS-12X5	12	5	M5 x 0,8	M3 x 0,5	38.20
KKS-12X10	12	10	M5 x 0,8	M3 x 0,5	40.70
KKS-12X15	12	15	M5 x 0,8	M3 x 0,5	41.70
KKS-12X20	12	20	M5 x 0,8	M3 x 0,5	44.35
KKS-12X25	12	25	M5 x 0,8	M3 x 0,5	44.60
KKS-12X30	12	30	M5 x 0,8	M3 x 0,5	46.00
KKS-12X35	12	35	M5 x 0,8	M3 x 0,5	47.65
KKS-12X40	12	40	M5 x 0,8	M3 x 0,5	49.35
KKS-12X45	12	45	M5 x 0,8	M3 x 0,5	50.45
KKS-12X50	12	50	M5 x 0,8	M3 x 0,5	52.80
KKS-16X5	16	5	M5 x 0,8	M4 x 0,7	39.00
KKS-16X10	16	10	M5 x 0,8	M4 x 0,7	40.80
KKS-16X15	16	15	M5 x 0,8	M4 x 0,7	41.70
KKS-16X20	16	20	M5 x 0,8	M4 x 0,7	43.35
KKS-16X25	16	25	M5 x 0,8	M4 x 0,7	44.60
KKS-16X30	16	30	M5 x 0,8	M4 x 0,7	46.00
KKS-16X35	16	35	M5 x 0,8	M4 x 0,7	47.65
KKS-16X40	16	40	M5 x 0,8	M4 x 0,7	49.35
KKS-16X45	16	45	M5 x 0,8	M4 x 0,7	50.45
KKS-16X50	16	50	M5 x 0,8	M4 x 0,7	52.80
KKS-16X55	16	55	M5 x 0,8	M4 x 0,7	57.10
KKS-16X60	16	60	M5 x 0,8	M4 x 0,7	58.35
KKS-20X5	20	5	M5 x 0,8	M5 x 0,8	40.20
KKS-20X10	20	10	M5 x 0,8	M5 x 0,8	41.30
KKS-20X15	20	15	M5 x 0,8	M5 x 0,8	42.10
KKS-20X20	20	20	M5 x 0,8	M5 x 0,8	43.20
KKS-20X25	20	25	M5 x 0,8	M5 x 0,8	44.65
KKS-20X30	20	30	M5 x 0,8	M5 x 0,8	46.00
KKS-20X35	20	35	M5 x 0,8	M5 x 0,8	47.80
KKS-20X40	20	40	M5 x 0,8	M5 x 0,8	49.55
KKS-20X45	20	45	M5 x 0,8	M5 x 0,8	51.15
KKS-20X50	20	50	M5 x 0,8	M5 x 0,8	51.35
KKS-20X60	20	60	M5 x 0,8	M5 x 0,8	56.10
KKS-20X70	20	70	M5 x 0,8	M5 x 0,8	59.95
KKS-20X75	20	75	M5 x 0,8	M5 x 0,8	62.85
KKS-20X80	20	80	M5 x 0,8	M5 x 0,8	65.85
KKS-20X90	20	90	M5 x 0,8	M5 x 0,8	71.60
KKS-20X100	20	100	M5 x 0,8	M5 x 0,8	77.60
KKS-25X5	25	5	M5 x 0,8	M6 x 1	45.70
KKS-25X10	25	10	M5 x 0,8	M6 x 1	47.65
KKS-25X15	25	15	M5 x 0,8	M6 x 1	47.80
KKS-25X20	25	20	M5 x 0,8	M6 x 1	48.85
KKS-25X25	25	25	M5 x 0,8	M6 x 1	49.45
KKS-25X30	25	30	M5 x 0,8	M6 x 1	51.60
KKS-25X35	25	35	M5 x 0,8	M6 x 1	53.30

0334					€
KKS-25X40	25	40	M5 x 0,8	M6 x 1	54.65
KKS-25X45	25	45	M5 x 0,8	M6 x 1	55.85
KKS-25X50	25	50	M5 x 0,8	M6 x 1	56.90
KKS-25X60	25	60	M5 x 0,8	M6 x 1	60.45
KKS-25X70	25	70	M5 x 0,8	M6 x 1	63.10
KKS-25X75	25	75	M5 x 0,8	M6 x 1	65.30
KKS-25X80	25	80	M5 x 0,8	M6 x 1	68.05
KKS-25X90	25	90	M5 x 0,8	M6 x 1	74.05
KKS-25X100	25	100	M5 x 0,8	M6 x 1	80.75
KKS-32X5	32	5	1/8"	M8 x 1,25	52.50
KKS-32X10	32	10	1/8"	M8 x 1,25	54.70
KKS-32X15	32	15	1/8"	M8 x 1,25	56.40
KKS-32X20	32	20	1/8"	M8 x 1,25	58.20
KKS-32X25	32	25	1/8"	M8 x 1,25	60.05
KKS-32X30	32	30	1/8"	M8 x 1,25	60.75
KKS-32X35	32	35	1/8"	M8 x 1,25	63.05
KKS-32X40	32	40	1/8"	M8 x 1,25	65.25
KKS-32X45	32	45	1/8"	M8 x 1,25	67.50
KKS-32X50	32	50	1/8"	M8 x 1,25	71.05
KKS-32X60	32	60	1/8"	M8 x 1,25	73.75
KKS-32X70	32	70	1/8"	M8 x 1,25	78.45
KKS-32X75	32	75	1/8"	M8 x 1,25	81.10
KKS-32X80	32	80	1/8"	M8 x 1,25	85.15
KKS-32X90	32	90	1/8"	M8 x 1,25	90.95
KKS-32X100	32	100	1/8"	M8 x 1,25	97.20
KKS-32X125	32	125	1/8"	M8 x 1,25	121.45
KKS-32X150	32	150	1/8"	M8 x 1,25	137.40
KKS-32X175	32	175	1/8"	M8 x 1,25	153.50
KKS-32X200	32	200	1/8"	M8 x 1,25	173.75
KKS-32X250	32	250	1/8"	M8 x 1,25	210.90
KKS-40X5	40	5	1/8"	M8 x 1,25	61.45
KKS-40X10	40	10	1/8"	M8 x 1,25	61.80
KKS-40X15	40	15	1/8"	M8 x 1,25	66.90
KKS-40X20	40	20	1/8"	M8 x 1,25	67.25
KKS-40X25	40	25	1/8"	M8 x 1,25	68.60
KKS-40X30	40	30	1/8"	M8 x 1,25	72.20
KKS-40X35	40	35	1/8"	M8 x 1,25	74.35
KKS-40X40	40	40	1/8"	M8 x 1,25	75.80
KKS-40X45	40	45	1/8"	M8 x 1,25	78.95
KKS-40X50	40	50	1/8"	M8 x 1,25	79.75
KKS-40X60	40	60	1/8"	M8 x 1,25	86.25
KKS-40X70	40	70	1/8"	M8 x 1,25	92.55
KKS-40X75	40	75	1/8"	M8 x 1,25	95.20
KKS-40X80	40	80	1/8"	M8 x 1,25	99.00
KKS-40X90	40	90	1/8"	M8 x 1,25	106.05

Persluchtcilinders

Tech Data **3027**

Compactcilinders

 **Werktemperatuur:**
-20°C tot +80°C

 **Werkdruk:**
1 tot 10 bar

Medium:

Geconditioneerde perslucht, gefilterd (40µm) en gesmeerd.

Met kunststof buffers





Behuizing: aluminium

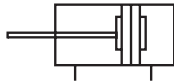



Afdichtingen: NBR

Volledige technische specificaties worden op aanvraag verstrekt



Magnetisch - dubbelwerkend

0334					€
KKS-40X100	40	100	1/8"	M8 x 1,25	113.00
KKS-40X125	40	125	1/8"	M8 x 1,25	143.15
KKS-40X150	40	150	1/8"	M8 x 1,25	161.10
KKS-40X175	40	175	1/8"	M8 x 1,25	178.75
KKS-40X200	40	200	1/8"	M8 x 1,25	196.80
KKS-40X250	40	250	1/8"	M8 x 1,25	244.75
KKS-50X5	50	5	1/4"	M10 x 1,5	83.65
KKS-50X10	50	10	1/4"	M10 x 1,5	85.40
KKS-50X15	50	15	1/4"	M10 x 1,5	89.05
KKS-50X20	50	20	1/4"	M10 x 1,5	89.95
KKS-50X25	50	25	1/4"	M10 x 1,5	93.50
KKS-50X30	50	30	1/4"	M10 x 1,5	96.85
KKS-50X35	50	35	1/4"	M10 x 1,5	99.50
KKS-50X40	50	40	1/4"	M10 x 1,5	99.85
KKS-50X45	50	45	1/4"	M10 x 1,5	104.90
KKS-50X50	50	50	1/4"	M10 x 1,5	106.75
KKS-50X60	50	60	1/4"	M10 x 1,5	112.35
KKS-50X70	50	70	1/4"	M10 x 1,5	118.20
KKS-50X75	50	75	1/4"	M10 x 1,5	121.45
KKS-50X80	50	80	1/4"	M10 x 1,5	124.40
KKS-50X90	50	90	1/4"	M10 x 1,5	132.85
KKS-50X100	50	100	1/4"	M10 x 1,5	140.95
KKS-50X125	50	125	1/4"	M10 x 1,5	176.90
KKS-50X150	50	150	1/4"	M10 x 1,5	196.50
KKS-50X175	50	175	1/4"	M10 x 1,5	218.90
KKS-50X200	50	200	1/4"	M10 x 1,5	239.00
KKS-50X250	50	250	1/4"	M10 x 1,5	289.95
KKS-63X5	63	5	1/4"	M10 x 1,5	95.20
KKS-63X10	63	10	1/4"	M10 x 1,5	98.80
KKS-63X15	63	15	1/4"	M10 x 1,5	102.35
KKS-63X20	63	20	1/4"	M10 x 1,5	105.85
KKS-63X25	63	25	1/4"	M10 x 1,5	109.80
KKS-63X30	63	30	1/4"	M10 x 1,5	113.00
KKS-63X35	63	35	1/4"	M10 x 1,5	120.50
KKS-63X40	63	40	1/4"	M10 x 1,5	121.05
KKS-63X45	63	45	1/4"	M10 x 1,5	123.35
KKS-63X50	63	50	1/4"	M10 x 1,5	127.45
KKS-63X60	63	60	1/4"	M10 x 1,5	134.55
KKS-63X70	63	70	1/4"	M10 x 1,5	141.90
KKS-63X75	63	75	1/4"	M10 x 1,5	142.70
KKS-63X80	63	80	1/4"	M10 x 1,5	150.05
KKS-63X90	63	90	1/4"	M10 x 1,5	159.50
KKS-63X100	63	100	1/4"	M10 x 1,5	166.90
KKS-63X125	63	125	1/4"	M10 x 1,5	206.00
KKS-63X150	63	150	1/4"	M10 x 1,5	227.50

0334					€
KKS-63X175	63	175	1/4"	M10 x 1,5	249.10
KKS-63X200	63	200	1/4"	M10 x 1,5	270.55
KKS-63X250	63	250	1/4"	M10 x 1,5	324.40
KKS-80X5	80	5	3/8"	M16 x 2	155.20
KKS-80X10	80	10	3/8"	M16 x 2	160.45
KKS-80X15	80	15	3/8"	M16 x 2	163.75
KKS-80X20	80	20	3/8"	M16 x 2	168.55
KKS-80X25	80	25	3/8"	M16 x 2	173.05
KKS-80X30	80	30	3/8"	M16 x 2	176.65
KKS-80X35	80	35	3/8"	M16 x 2	181.45
KKS-80X40	80	40	3/8"	M16 x 2	185.05
KKS-80X45	80	45	3/8"	M16 x 2	189.60
KKS-80X50	80	50	3/8"	M16 x 2	194.15
KKS-80X60	80	60	3/8"	M16 x 2	203.50
KKS-80X70	80	70	3/8"	M16 x 2	213.95
KKS-80X75	80	75	3/8"	M16 x 2	219.35
KKS-80X80	80	80	3/8"	M16 x 2	224.60
KKS-80X90	80	90	3/8"	M16 x 2	237.50
KKS-80X100	80	100	3/8"	M16 x 2	250.80
KKS-80X125	80	125	3/8"	M16 x 2	308.05
KKS-80X150	80	150	3/8"	M16 x 2	339.40
KKS-80X175	80	175	3/8"	M16 x 2	370.80
KKS-80X200	80	200	3/8"	M16 x 2	402.20
KKS-80X250	80	250	3/8"	M16 x 2	477.65
KKS-100X5	100	5	3/8"	M20 x 2,5	234.30
KKS-100X10	100	10	3/8"	M20 x 2,5	239.25
KKS-100X15	100	15	3/8"	M20 x 2,5	243.50
KKS-100X20	100	20	3/8"	M20 x 2,5	249.05
KKS-100X25	100	25	3/8"	M20 x 2,5	253.80
KKS-100X30	100	30	3/8"	M20 x 2,5	259.30
KKS-100X35	100	35	3/8"	M20 x 2,5	264.40
KKS-100X40	100	40	3/8"	M20 x 2,5	268.90
KKS-100X45	100	45	3/8"	M20 x 2,5	274.40
KKS-100X50	100	50	3/8"	M20 x 2,5	279.70
KKS-100X60	100	60	3/8"	M20 x 2,5	289.35
KKS-100X70	100	70	3/8"	M20 x 2,5	300.45
KKS-100X75	100	75	3/8"	M20 x 2,5	304.65
KKS-100X80	100	80	3/8"	M20 x 2,5	311.00
KKS-100X90	100	90	3/8"	M20 x 2,5	323.25
KKS-100X100	100	100	3/8"	M20 x 2,5	335.65
KKS-100X125	100	125	3/8"	M20 x 2,5	407.55
KKS-100X150	100	150	3/8"	M20 x 2,5	438.95
KKS-100X175	100	175	3/8"	M20 x 2,5	470.35
KKS-100X200	100	200	3/8"	M20 x 2,5	501.80
KKS-100X250	100	250	3/8"	M20 x 2,5	579.30

KELMKTM pneumatiek

Hydrauliek

Snelkoppelingen

Afsluiters

Roestvast staal

Fittingen

Luchtconditionering

Gereedschap

Pneumatiek

Diversen

Malleabele fittingen & staal

Ringleidingssystemen

Slangen

Compressoren

Compactcilinder bevestigingen

Tech Data
3028



Gaffelscharnier achter CB

0334	∅ mm	€
KSS-12-CB	12	9.80
KSS-16-CB	16	10.10
KSS-20-CB	20	11.45
KSS-25-CB	25	12.65
KSS-32-CB	32	14.20
KSS-40-CB	40	15.75
KSS-50-CB	50	17.60
KSS-63-CB	63	20.00
KSS-80-CB	80	28.10
KSS-100-CB	100	28.65

Tech Data
3029



Flensbevestiging voor/achter FA/FB

0334	∅ mm	€
KSS-12-FAFB	12	7.05
KSS-16-FAFB	16	7.15
KSS-20-FAFB	20	7.65
KSS-25-FAFB	25	8.65
KSS-32-FAFB	32	9.80
KSS-40-FAFB	40	10.60
KSS-50-FAFB	50	12.50
KSS-63-FAFB	63	16.20
KSS-80-FAFB	80	23.15
KSS-100-FAFB	100	28.60

Tech Data
3030



Bevestigingsvoet LB (paar)

0334	∅ mm	To Suit Stroke	€
KSS-12-LB	12	Alle	5.90
KSS-16-LB	16	Alle	6.00
KSS-20-LB	20	>15	6.25
KSS-25-LB	25	>10	6.35
KSS-32-LB	32	>10	7.15
KSS-40-LB	40	Alle	7.50
KSS-50-LB	50	>15	8.25
KSS-63-LB	63	>10	11.45
KSS-80-LB	80	>20	12.60
KSS-100-LB	100	>15	14.35

Bevestigingsvoet LBS (paar) - korte slaglengte

0334	∅ mm	To Suit Stroke	€
KSS-20-LBS-P1	20	<10	6.20
KSS-25-LBS-P1	25	<5	6.35
KSS-32-LBS-P1	32	<5	7.00
KSS-50-LBS-P1	50	<10	9.45
KSS-63-LBS-P1	63	<5	11.45
KSS-80-LBS-P1	80	<15	12.40
KSS-100-LBS-P1	100	<10	14.10

Compactcilinder magneetschakelaars

Tech Data
3031



Tweepolig - NO met LED - 2 meter

0334	∅ mm	⚡	€
KSS1-G	32-1005-240V AC/DC		16.75

Compactcilinder revisieset



Standaard

Tech Data
20388

0334	∅	€
KKSRK-12	12	3.65
KKSRK-16	16	3.80
KKSRK-20	20	4.80
KKSRK-25	25	5.15
KKSRK-32	32	5.40
KKSRK-40	40	6.95
KKSRK-50	50	8.30
KKSRK-63	63	10.10
KKSRK-80	80	15.50
KKSRK-100	100	18.60



Viton

Tech Data
20389

0334	∅	€
KKSRK-12-V	12	8.65
KKSRK-16-V	16	10.50
KKSRK-20-V	20	12.40
KKSRK-25-V	25	14.25
KKSRK-32-V	32	14.45
KKSRK-40-V	40	18.25
KKSRK-50-V	50	24.80
KKSRK-63-V	63	31.95
KKSRK-80-V	80	50.10
KKSRK-100-V	100	57.10

Pneumatische grijpers

Hoekgrijper

Tech Data
20470

- Maakt gebruik van één zuiger voor het genereren van een grote grijpkracht
- Geïntegreerde eenvoudige snelheidsregeling t.b.v. de opening en sluitingssnelheid van de grijpklauwen
- Nauwkeurige positionering bij het grijpen van componenten
- Huis met groeven voor directe montage van een magneetschakelaar
- Geïntegreerde magneet voor extra controle
- Hoek van opening en sluiting van de grijpklauw: 30° tot -10°
- Enkelwerkende NO versie op aanvraag leverbaar
- Uitwisselbaar met SMC



KHFY: Double Acting

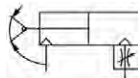

Dubbelwerkend

0415				
KHFY6	M3 x 0.5	6	30	88.55
KHFY10	M3 x 0.5	10	30	88.55
KHFY16	M5 x 0.8	16	40	94.45
KHFY20	M5 x 0.8	20	60	106.15
KHFY25	M5 x 0.8	25	70	124.00
KHFY32	M5 x 0.8	32	85	147.60

Parallelgrijper

Tech Data
20471

- Geïntegreerde lineaire geleiding voor hoge precisie en stijfheid
- Positioneringspin om afwijking van de geleider en het huis te voorkomen
- Om de precisie en consistentie te verbeteren bij het demontieren en positioneren is de unit voorzien van een dieper gat in het huis
- Grijpklauwen met variabele positionering
- Huis met groeven voor directe montage van een magneetschakelaar
- Andere grijptypes en enkelwerkende NO of NC versies op aanvraag leverbaar
- Uitwisselbaar met SMC

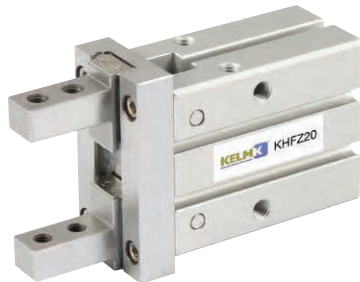

KHfZ: Double Acting

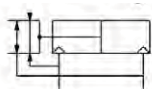

Dubbelwerkend

0415						
KHfZ10	M3 x 0.5	6	5-50	15.5	11.5	191.90
KHfZ16	M5 x 0.8	16	5-55	21.0	15.0	200.65
KHfZ20	M5 x 0.8	20	5-80	26.5	16.5	221.50
KHfZ25	M5 x 0.8	25	5-100	33.5	19.5	265.70

Productselectie

Selecteer pneumatische gripper op basis van de volgende gegevens:
Effectieve grijpkracht → het grijppunt → externe kracht op de grijpklauw
1. Calculatie van de grijpkracht:

The work-pieces as shown in the left:
F: Gripping force (N)
μ: friction coefficient between fittings and work-pieces.
m: mass of work-pieces
g: acceleration of gravity (=9.8m/s²)

The condition that the work-pieces won't drop is: $2 \times \mu F > mg$
so: $F > \frac{mg}{2 \times \mu}$
Safety coefficient is a, so F is:
 $F = \frac{mg}{2 \times \mu} \times a$

Note: If the friction coefficient $\mu > 0.2$, for safety, please also select clamping force according to the principle of 10-20 times of the mass of the clamped objects. As for large acceleration and shock, it requires for greater safety coefficient.

$\mu = 0.2$ $F = \frac{mg}{2 \times 0.2} \times 4$ $= 10 \times mg$	$\mu = 0.1$ $F = \frac{mg}{2 \times 0.1} \times 4$ $= 20 \times mg$
10 times of the mass of the gripped objects	20 times of the mass of the gripped objects

Magneetschakelaar

Tech Data
20472



Tweepolig - NO

0415				
KDS1-H-C08	Recht	Met M8 stekker	0.15m	22.90
KDS1-H-020	Recht	-	2m	18.55
KDS1-H-030	Recht	-	3m	19.55
KDS1-H-050	Recht	-	5m	21.60
KDS1-HL-C08	90°	Met M8 stekker	0.15m	22.90
KDS1-HL-020	90°	-	2m	18.55
KDS1-HL-030	90°	-	3m	19.55
KDS1-HL-050	90°	-	5m	21.60

Driepolig - NO - contactloos - ingaande stroming NPN

0415				
KDS1-H-N-C08	Recht	Met M8 stekker	0.15m	32.05
KDS1-H-N-020	Recht	-	2m	27.60
KDS1-H-N-030	Recht	-	3m	29.05
KDS1-H-N-050	Recht	-	5m	31.70
KDS1-HL-N-C08	90°	Met M8 stekker	0.15m	32.05
KDS1-HL-N-020	90°	-	2m	27.60
KDS1-HL-N-030	90°	-	3m	29.05
KDS1-HL-N-050	90°	-	5m	31.70

Driepolig - NO - contactloos - uitgaande stroming PNP

0415				
KDS1-H-P-C08	Recht	Met M8 stekker	0.15m	32.05
KDS1-H-P-020	Recht	-	2m	27.60
KDS1-H-P-030	Recht	-	3m	29.05
KDS1-H-P-050	Recht	-	5m	31.70
KDS1-HL-P-C08	90°	Met M8 stekker	0.15m	32.05
KDS1-HL-P-020	90°	-	2m	27.60
KDS1-HL-P-030	90°	-	3m	29.05
KDS1-HL-P-050	90°	-	5m	31.70

KELM™ pneumatiek
Hydrauliek
Snelkoppelingen
Afsluiters
Roestvast staal
Fittingen
Luchtconditionering
Gereedschap
Pneumatiek
Diversen
Malleabele fittingen & staal
Ringleidingssystemen
Slangen
Compressoren

Tech Data 3097



Werktemperatuur:
-20°C tot +70°C

Werkdruk:
0 tot 10 bar

Medium: Geconditioneerde perslucht. Gefilterd (40µm).

Materiaal: Aluminiumlegering

Afdichtingen: NBR

Volledige technische specificaties worden op aanvraag verstrekt

Mechanisch bediende 3/2 ventielen - micro paneelmontage

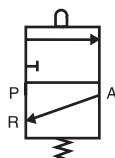

Stift

0335



K3M3B-05	M5	26.50
K3M3B-06	1/8"	26.50
K3M3B-08	1/4"	33.95

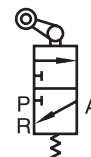

Rolarm - 1 richting

0335



K3M3L-05	M5	38.60
K3M3L-06	1/8"	38.60
K3M3L-08	1/4"	46.15

Handbediende 3/2 ventielen - micro paneelmontage

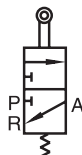

Rolarm

0335



K3M3R-05	M5	38.60
K3M3R-06	1/8"	38.60
K3M3R-08	1/4"	46.15



Hefboom/hefboom

0335



K3M3Y-05	M5	43.55
K3M3Y-06	1/8"	43.55
K3M3Y-08	1/4"	50.85

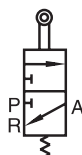

Roller

0335



K3M3V-05	M5	38.60
K3M3V-06	1/8"	38.60
K3M3V-08	1/4"	46.15

Tech Data 3097



Werktemperatuur:
-20°C tot +70°C

Werkdruk:
0 tot 10 bar

Medium: Geconditioneerde perslucht. Gefilterd (40µm).

Materiaal: Aluminiumlegering

Afdichtingen: NBR

Volledige technische specificaties worden op aanvraag verstrekt

Handbediende 3/2 ventielen - micro paneelmontage



Drukknop (omhuld)

0335



K3M3PF-05-B	M5	Zwart	43.55
K3M3PF-05-G	M5	Groen	43.55
K3M3PF-05-R	M5	Rood	43.55
K3M3PF-06-B	1/8"	Zwart	43.55
K3M3PF-06-G	1/8"	Groen	43.55
K3M3PF-06-R	1/8"	Rood	43.55
K3M3PF-08-B	1/4"	Zwart	50.85
K3M3PF-08-G	1/4"	Groen	50.85
K3M3PF-08-R	1/4"	Rood	50.85



Drukknop (extern)

0335



K3M3PP-05-B	M5	Zwart	43.55
K3M3PP-05-G	M5	Groen	43.55
K3M3PP-05-R	M5	Rood	43.55
K3M3PP-06-B	1/8"	Zwart	43.55
K3M3PP-06-G	1/8"	Groen	43.55
K3M3PP-06-R	1/8"	Rood	43.55
K3M3PP-08-B	1/4"	Zwart	50.85
K3M3PP-08-G	1/4"	Groen	50.85
K3M3PP-08-R	1/4"	Rood	50.85



Paddestoelknop

0335



K3M3PM-05-B	M5	Zwart	43.55
K3M3PM-05-G	M5	Groen	43.55
K3M3PM-05-R	M5	Rood	43.55
K3M3PM-06-B	1/8"	Zwart	43.55
K3M3PM-06-G	1/8"	Groen	43.55
K3M3PM-06-R	1/8"	Rood	43.55
K3M3PM-08-B	1/4"	Zwart	50.85
K3M3PM-08-G	1/4"	Groen	50.85
K3M3PM-08-R	1/4"	Rood	50.85

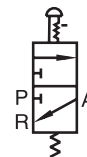

Paddestoelknop - vergrendeling

0335



K3M3PL-05-R	M5	Rood	43.55
K3M3PL-06-R	1/8"	Rood	43.55
K3M3PL-08-R	1/4"	Rood	50.85

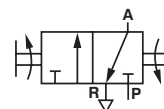

Schakelaar - 2 posities

0335



K3M3HS05	M5	43.55
K3M3HS06	1/8"	43.55
K3M3HS08	1/4"	50.85

KELM™
pneumatiek

Hydrauliek

Snel-
koppelingen

Afsluiters

Roestvast
staal

Fittingen

Lucht-
conditionering

Gereedschap

Pneumatiek

Diversen

Malleabele
fittingen &
staal

Ringleiding-
systemen

Slangen

Compressoren

Hand- en mechanisch bediende ventielen



Werktemperatuur:
-20°C tot +70°C

Werkdruk:
0 tot 8 bar

Medium: Geconditioneerde perslucht, gefilterd (40µm) en gesmeerd.
Materiaal: Aluminiumlegering
Afdichtingen: NBR
Volledige technische specificaties worden op aanvraag verstrekt

Handbediende 3/2 ventielen

Tech Data
3032



Trek/druk

0335



CKL110-06	1/8"	26.35
CKL210-08	1/4"	29.85
CKL310-10	3/8"	40.50

Tech Data
3038

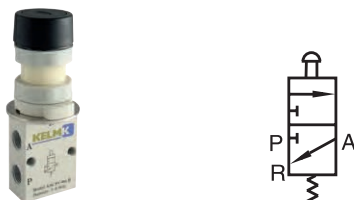

Drukknop (omhuld)

0335



KSCPF-06-B	1/8"	Zwart	25.00
KSCPF-06-G	1/8"	Groen	25.00
KSCPF-06-R	1/8"	Rood	25.00

Tech Data
3038



Drukknop (extern)

0335



KSCPP-06-B	1/8"	Zwart	25.00
KSCPP-06-G	1/8"	Groen	25.00
KSCPP-06-R	1/8"	Rood	25.00

Tech Data
3038



Paddestoelknop

0335



KSCPM-06-B	1/8"	Zwart	26.95
KSCPM-06-G	1/8"	Groen	26.95
KSCPM-06-R	1/8"	Rood	26.95

Tech Data
3038



Paddestoelknop - vergrendeling

0335



KSCPL-06-R	1/8"	Rood	26.85
------------	------	------	-------

Tech Data
3038



Hefboom/hefboom

0335



KSY-06	1/8"		26.85
--------	------	--	-------

Tech Data
3038

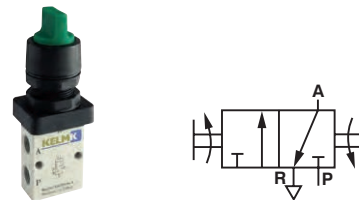

Schakelaar

0335



KSCHS-06-B	1/8"	Zwart	26.85
KSCHS-06-G	1/8"	Groen	26.85
KSCHS-06-R	1/8"	Rood	26.85



Werktemperatuur:
-20°C tot +70°C

Mechanisch bediende 3/2 ventielen

Tech Data
3038

Werkdruk:
0 tot 8 bar

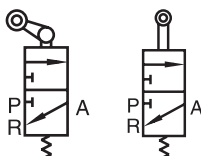

Rolnok

0335



KSCL-06	1/8"	Rolnok eenrichting hefboom	25.85
KSCR-06	1/8"	Rolnok hefboom	25.85
KSCV-06	1/8"	Rolnok	25.85

Tech Data
3038

Werkdruk:
0 tot 8 bar

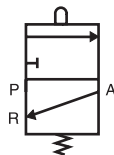

Stift

0335



KCB-06	1/8"		19.60
--------	------	--	-------

Tech Data
10061

Werkdruk:
0 tot 10 bar



Rolnok/veer

0335



ZMCR-06-W	1/8"		85.50
-----------	------	--	-------

Tech Data
10061

Werkdruk:
0 tot 10 bar

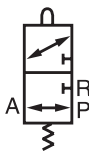

Verstelbare rolnok/veer

0335



ZMCJ-06-W	1/8"		89.00
-----------	------	--	-------

Tech Data
10061

Werkdruk:
0 tot 10 bar

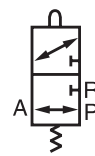

Antenne/veer

0335



ZMCP-06-W	1/8"		89.00
-----------	------	--	-------

Handbediende 4/2 ventielen

Tech Data
3033

Werkdruk:
0 tot 10 bar

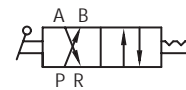

Hefboom/hefboom

0335



DKHV210-06-S	1/8"	39.20
DKHV310-08-S	1/4"	49.45
DKHV310-10-S	3/8"	49.45
DKHV410-15-S	1/2"	69.50
DKHV410-20-S	3/4"	70.55

Handbediende 4/3 ventielen

Tech Data
3033

Werkdruk:
0 tot 10 bar

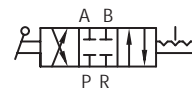

Hefboom/hefboom/hefboom - gesloten middenstand

0335



DKHV230-C-06-S	1/8"	39.20
DKHV330-C-08-S	1/4"	49.45
DKHV330-C-10-S	3/8"	49.45
DKHV430-C-15-S	1/2"	69.50
DKHV430-C-20-S	3/4"	70.55

- KELM™ pneumatiek
- Hydrauliek
- Snelkoppelingen
- Afsluiters
- Roestvast staal
- Fittingen
- Luchtconditionering
- Gereedschap
- Pneumatiek
- Diversen
- Malleabele fittingen & staal
- Ringleidingssystemen
- Slangen
- Compressoren



Werktemperatuur:
-20°C tot +70°C

Werkdruk:
0 tot 8 bar

Handbediende 5/2 ventielen

Tech Data
3034



Trek/druk

0335



DKL110-06	1/8"	27.40
DKL210-08	1/4"	32.05
DKL310-10	3/8"	47.30

Tech Data
3041



Hefboom/hefboom

0335



DKH210-06	1/8"	35.55
DKH310-08	1/4"	51.20
DKH310-10	3/8"	51.20

Handbediende 5/3 ventielen

Tech Data
3045

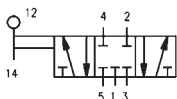

Hefboom/hefboom/hefboom - gesloten middenstand

0335



DKH230-C-06	1/8"	57.90
DKH230-C-08	1/4"	57.90
DKH330-C-10	3/8"	58.20

Tech Data
3046

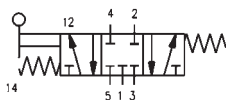

Hefboom/veer/hefboom - gesloten middenstand

0335



DKHA230-C-06	1/8"	68.05
DKHA230-C-08	1/4"	68.05
DKHA330-C-10	3/8"	69.50

Voetbediende 5/2 ventielen

Tech Data
3055

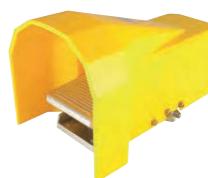

Voet/veer

0335



DKF210-08	-	55.20
DKF210-08G	Beschermd	65.75

Tech Data
3055

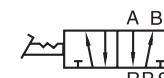

Voet/voet

0335



DKF210-08L	-	61.60
DKF210-08LG	Beschermd	73.50

Flowregelaars

Tech Data
3056

Werkdruk:
0,5 tot 10 bar

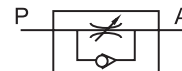

Einrichting

0335



K100-06	1/8"	11.60
K200-08	1/4"	13.25
K300-10	3/8"	33.15
K300-15	1/2"	33.90

Handschuifventielen 3/2

Tech Data
3035

Werkdruk:
0-10 bar



BSP female

0335



KSV-06	1/8"	12.25
KSV-08	1/4"	13.20
KSV-10	3/8"	16.10
KSV-15	1/2"	27.85
KSV-20	3/4"	45.95
KSV-25	1"	68.65

Luchtbediende ventielen



Werktemperatuur:
-20°C tot +70°C

Werkdruk:
1,5 tot 8 bar

Medium: Geconditioneerde perslucht, gefilterd (40µm) en gesmeerd.
Materiaal: Aluminiumlegering Afdichtingen: NBR
Volledige technische specificaties worden op aanvraag verstrekt

Luchtbediende 3/2 ventielen

Tech Data
3036

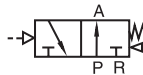

Pilot/veer - NO

0335



CKA210-06-NO	1/8"	37.00
CKA210-08-NO	1/4"	40.70
CKA310-10-NO	3/8"	71.05

Tech Data
3036

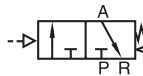

Pilot/veer - NC

0335



CKA210-06-NC	1/8"	37.00
CKA210-08-NC	1/4"	40.70
CKA310-10-NC	3/8"	71.05

Tech Data
3036

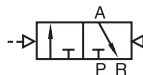

Pilot/pilot

0335



CKA220-06	1/8"	49.55
CKA220-08	1/4"	54.50
CKA320-10	3/8"	85.80

Luchtbediende 5/2 ventielen

Tech Data
3037



Pilot/veer

0335



DKA210-06	1/8"	48.45
DKA210-08	1/4"	48.45
DKA310-10	3/8"	54.10
DKA410-15	1/2"	73.75

Tech Data
3037



Pilot/pilot

0335



DKA220-06	1/8"	53.30
DKA220-08	1/4"	53.30
DKA320-10	3/8"	62.60
DKA420-15	1/2"	84.35

KELMK™
pneumatiek

Hydrauliek

Snel-
koppelingen

Afsluiters

Roestvast
staal

Fittingen

Lucht-
conditionering

Gereedschap

Pneumatiek

Diversen

Malleabele
fittingen
& staal

Ringleiding-
systemen

Slangen

Compressoren



Werktemperatuur:
-20°C tot +70°C

Werkdruk:
1,5 tot 8 bar

Medium: Geconditioneerde perslucht, gefilterd (40µm) en gesmeerd.
Materiaal: Aluminiumlegering **Afdichtingen:** NBR
Volledige technische specificaties worden op aanvraag verstrekt

Luchtbediende 5/3 ventielen

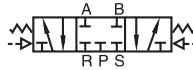

Pilot/pilot - gesloten middenstand

0335	BSPP	€
DKA230C-06	1/8"	77.45
DKA230C-08	1/4"	85.15
DKA330C-10	3/8"	93.70
DKA430C-15	1/2"	112.25



Pilot/pilot - middenstand druk

0335	BSPP	€
DKA230P-06	1/8"	77.45
DKA230P-08	1/4"	85.15
DKA330P-10	3/8"	93.70
DKA430P-15	1/2"	112.25



Pilot/pilot - middenstand ontlucht

0335	BSPP	€
DKA230E-06	1/8"	77.45
DKA230E-08	1/4"	85.15
DKA330E-10	3/8"	93.70
DKA430E-15	1/2"	112.25

Elektrisch bediende ventielen



Werktemperatuur:
-20°C tot +70°C

Werkdruk:
1,5 tot 8 bar

Medium: Schone perslucht. Gefilterd (40µm) & gesmeerd.
Materiaal: Aluminiumlegering **Afdichtingen:** NBR
Volledige technische specificaties worden op aanvraag verstrekt

Elektrisch bediende 3/2 ventielen

Tech Data
3107



Direct werkend - NC - M5

0335



KCV1-M5-B	24V DC	41.30
KCV1-M5-C	110V 50/60Hz	41.30
KCV1-M5-A	220V 50/60Hz	41.30

Tech Data
3107



Direct werkend - NC - 1/8"

0335



KCV1-06-B	24V DC	41.30
KCV1-06-C	110V 50/60Hz	41.30
KCV1-06-A	220V 50/60Hz	41.30

Tech Data
3039

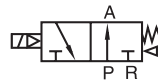

Solenoid/veer - NO

0335



CKV210-06-NO	1/8"	33.30
CKV210-08-NO	1/4"	36.65
CKV310-10-NO	3/8"	54.10

Tech Data
3039

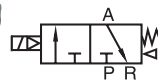

Solenoid/veer - NC

0335



CKV210-06-NC	1/8"	34.95
CKV210-08-NC	1/4"	38.45
CKV310-10-NC	3/8"	54.80

Tech Data
3039



Solenoid/solenoid

0335



CKV220-06	1/8"	55.90
CKV220-08	1/4"	61.55
CKV320-10	3/8"	85.70

Bevestigingscomponenten

Tech Data
3107



Koppelingsschroef en O-ring

0335



KCV1-P31	2.15
----------	------

Tech Data
3107



Koppelingsschroef en (eind)bevestigingsmoer

0335



KCV1-P30	2.50
----------	------

Tech Data
3107



Basisplaat

0335



KCV1-P32	2.50
----------	------

KELM™
pneumatiek

Hydrauliek

Snel-
koppelingen

Afsluiters

Roestvast
staal

Fittingen

Lucht-
conditionering

Gereedschap

Pneumatiek

Diversen

Malleabele
fittingen &
staal

Ringleiding-
systemen

Slangen

Compressoren



Werktemperatuur:
-20°C tot +70°C

Werkdruk:
1,5 tot 8 bar

Medium: Schone perslucht. Gefilterd (40µm) & gesmeerd.
Materiaal: Aluminiumlegering **Afdichtingen:** NBR
Volledige technische specificaties worden op aanvraag verstrekt

Elektrisch bediende 5/2 ventielen

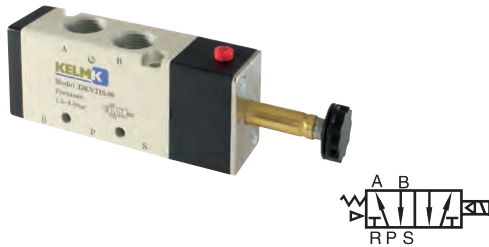

Solenoid/veer

0335	BSPP	€
DKV210-06	1/8"	34.95
DKV210-08	1/4"	38.45
DKV310-10	3/8"	53.90
DKV410-15	1/2"	73.50

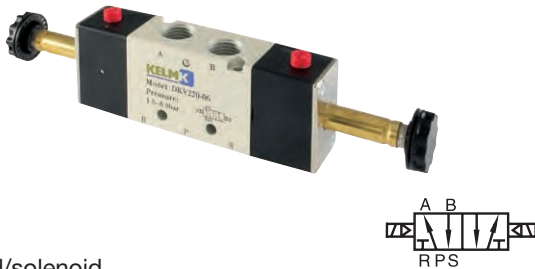

Solenoid/solenoid

0335	BSPP	€
DKV220-06	1/8"	54.45
DKV220-08	1/4"	57.40
DKV320-10	3/8"	85.70
DKV420-15	1/2"	105.55

Elektrisch bediende 5/3 ventielen

Alleen te gebruiken bij 5/2 ventielen



Solenoid/solenoid - gesloten middenstand

0335	BSPP	€
DKV230C-06	1/8"	76.60
DKV230C-08	1/4"	79.85
DKV330C-10	3/8"	121.30
DKV430C-15	1/2"	139.15



Solenoid/solenoid - middenstand ontluft

0335	BSPP	€
DKV230E-06	1/8"	76.60
DKV230E-08	1/4"	76.60
DKV330E-10	3/8"	115.15
DKV430E-15	1/2"	138.60



Solenoid/solenoid - middenstand druk

0335	BSPP	€
DKV230P-06	1/8"	77.90
DKV230P-08	1/4"	85.75
DKV330P-10	3/8"	115.15
DKV430P-15	1/2"	137.10



Basisplaten

Tech Data
3042



1/4" BSP

0335	No. of Stations	€
B00KM-1F	1	11.65
B00KM-2F	2	12.25
B00KM-3F	3	18.35
B00KM-4F	4	23.80
B00KM-5F	5	29.40
B00KM-6F	6	35.95
B00KM-8F	8	47.80
B00KM-10F	10	58.80

3/8" BSP

0335	No. of Stations	€
C00KM-1F	1	14.35
C00KM-2F	2	16.65
C00KM-3F	3	25.30
C00KM-4F	4	33.70
C00KM-5F	5	42.25
C00KM-6F	6	50.70
C00KM-8F	8	67.50
C00KM-10F	10	84.35

Het maximaal beschikbare aantal stations is 8

1/2" BSP

0335	No. of Stations	€
D00KM-1F	1	26.90
D00KM-2F	2	32.70
D00KM-3F	3	48.10
D00KM-4F	4	65.30
D00KM-5F	5	81.65
D00KM-6F	6	97.95
D00KM-8F	8	133.70

Blindplaten

Tech Data
3042

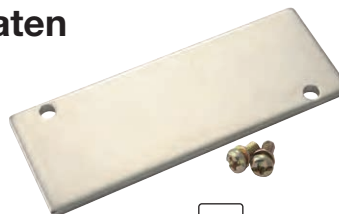

Enkel

0335	To Suit	€
B00KM-B	B-serie	0.70
C00KM-B	C-serie	1.60
D00KM-B	D-serie	4.10

Namur 5/2 ventielen

Tech Data
3043



Solenoid/veer

0335	BSPP	€
DKM310-08	1/4"	66.40
DKM310-10	3/8"	73.15

Tech Data
3043



Solenoid/solenoid

0335	BSPP	€
DKM320-08	1/4"	101.10
DKM320-10	3/8"	111.30

Spoelen met stekker

Tech Data
3044



Spoel en LED stekker

0335	€
K-12DC	12V DC 22.90
K-24DC	24V DC 19.90
K-24AC	24V 50/60Hz 19.90
K-110AC	110V 50/60Hz 19.90
K-220AC	220V 50/60Hz 19.90

- KELM™ pneumatiek
- Hydrauliek
- Snelkoppelingen
- Afsluiters
- Roestvast staal
- Fittingen
- Luchtconditionering
- Gereedschap
- Pneumatiek
- Diversen
- Malleabele fittingen & staal
- Ringleidingssystemen
- Slangen
- Compressoren



Werktemperatuur:
0°C tot +60°C



Werkdruk:
2 tot 10 bar

Basisventiel - NOT



4mm push-in

0335

KP080394



33.75

Tweedrukventiel - AND



4mm push-in

0335

KP080254



23.05

Basisventiel - YES



4mm push-in

0335

KP080494



33.75

Monostabiel ventiel



4mm push-in

0335

KP040034



59.65

Wisselventiel - OR



4mm push-in

0335

KP080214



23.05

Voor

AEROPRO
ENGINEERED FOR PROFESSIONALS

pneumatisch
gereedschap



...zie pagina 526

- KELM™ pneumatiek
- Hydrauliek
- Snel-koppelingen
- Afsluiters
- Roestvast staal
- Fittingen
- Lucht-conditionering
- Gereedschap
- Pneumatiek
- Diversen
- Malleabele fittingen & staal
- Ringleiding-systemen
- Slangen
- Compressoren



Werktemperatuur:
0°C tot +60°C

Impuls ventielen

Tech Data
3099

Werkdruk:
2 tot 10 bar



1/8" BSP - NO

0335

KP100014



57.20

Tech Data
3099

Werkdruk:
2 tot 10 bar



1/8" BSP - NC

0335

KP100094



57.20

Oscillatie ventielen

Tech Data
3100

Werkdruk:
2 tot 10 bar



1/4" BSP - continue cyclus

0335

KP010444



171.85

Tech Data
3100

Werkdruk:
2 tot 10 bar



1/4" BSP - luchtbediend

0335

KP010464



183.65

Flip Flop ventiel

Tech Data
3103

Werkdruk:
3 tot 10 bar



1/4" BSP - luchtbediend

0335

KP100354



195.20

KELM™
pneumatiek

Hydrauliek

Snel-
koppelingen

Afsluiters

Roestvast
staal

Fittingen

Lucht-
conditionering

Gereedschap

Pneumatiek

Diversen

Malleabele
fittingen
& staal

Ringleiding-
systemen

Slangen

Compressoren



Werktemperatuur:
0°C tot +60°C

High flow pneumatische timer

Tech Data
3101

Werkdruk:
2 tot 10 bar



Voor automatische teruggang - 1/8" BSP

0335

KP000744



128.50

Vacuümgedreven vloeistofspoeier

Tech Data
3102

Werkdruk:
3 tot 8 bar



M5

0335

KP2005



33.75

KELM™
pneumatiek

Hydrauliek

Snel-
koppelingen

Afsluiters

Roestvast
staal

Fittingen

Lucht-
conditionering

Gereedschap

Pneumatiek

Diversen

Malleabele
fittingen
& staal

Ringleiding-
systemen

Slangen

Compressoren

Veiligheidsunit (voor 2-handsgebruik)

Tech Data
3099



Werktemperatuur:
0°C tot +60°C

Werkdruk:
3 tot 8 bar

4mm push-in

Basis veiligheidsunit - 1/8" BSP

0341

KP081564



492.85

0341

KPBU081564



192.05



Deze geassembleerde unit is speciaal ontworpen met de veiligheid van operators in gedachten.

De unit vereist beide handen van de operator om te functioneren. Als beide 3/2 drukknop ventielen niet geactiveerd zijn binnen 0.5 seconden zal de unit niet in werking worden gesteld.



Pneumatische kogelvibratoren

Tech Data
1012



Max. omgevings-temperatuur
+100°C



Werkdruk
Minimaal 2 bar
Maximaal 6 bar

- Deze pneumatische kogelvibrator veroorzaakt door middel van een roterende kogel een roterende trilling. De frequentie kan geregeld worden door aanpassing van de persluchtdruk
- Toepassing: Het in beweging houden, verdichten en losstrillen van stortgoed. Voorbeelden: Chemische poeders, graan, zand, grind en cement.
- Voor binnen- en buitengebruik, maar niet bestand tegen onderdempeling in vloeistof.

BSP female

0314				Air Consumption at 6 bar	V.P.M. 6 bar	€
JM8	1/4"	2	6	195 liter	35100	102.05
JM10	1/4"	2	6	200 liter	34100	107.15
JM13	1/4"	2	6	225 liter	22510	148.10
JM16	1/4"	2	6	280 liter	19510	183.75
JM20	1/4"	2	6	340 liter	16510	220.30
JM25	1/4"	2	6	425 liter	14100	244.80
JM30	3/8"	2	6	570 liter	12510	318.30
JM36	3/8"	2	6	675 liter	10100	352.60

Pneumatische turbinevibratoren

Tech Data
1013



Max. omgevings-temperatuur
+120°C



Werkdruk
Minimaal 2 bar
Maximaal 6 bar

- Deze pneumatische turbinevibrator veroorzaakt door middel van een excentrisch roterende rotor een roterende trilling. De frequentie kan geregeld worden door aanpassing van de persluchtdruk.
- Toepassing: Het in beweging houden, verdichten en losstrillen van stortgoed in o.a. silo's. Voorbeelden: Chemische poeders, graan, zand, grind en cement.

BSP female

0314				Air Consumption at 6 bar	V.P.M. 6 bar	€
JMT8	1/8"	2	6	120 liter	45900	146.90
JMT10	1/4"	2	6	120 liter	37600	163.50
JMT13	1/4"	2	6	290 liter	39800	195.90
JMT16	1/4"	2	6	290 liter	24100	205.65
JMT20	1/4"	2	6	455 liter	23100	274.85
JMT25	3/8"	2	6	455 liter	17100	306.40
JMT30	3/8"	2	6	745 liter	16100	553.60
JMT36	3/8"	2	6	745 liter	13000	622.75

- Mais
- Cement
- Chemische poeders
- Zand
- Grind

Pneumatische zuigervibratoren

Tech Data
10158

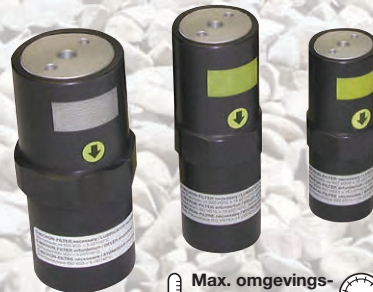

Max. omgevings-temperatuur
+100°C



Werkdruk
Minimaal 2 bar
Maximaal 6 bar

Aluminium - BSP female

0314				Air Consumption at 6 bar	€
KFP-12-M	1/8"	2	6	20 liter	286.55
KFP-18-M	1/8"	2	6	55 liter	298.50
KFP-25-M	1/4"	2	6	88 liter	298.50
KFP-35-M	1/4"	2	6	145 liter	398.10

Persluchtcilinders



ISO 6432 rondcilinders

Medium:

Gefilterde, gesmeerde en ongesmeerde perslucht

Materiaal: Cilinderbuis: RVS AISI-304

Zuigerstang: RVS AISI-303

Kappen: geanodiseerd aluminium

Dichting: NBR/PU

Temperatuur:
0°C tot 80°C
(-20°C bij droge lucht)

Maximale werkdruk:
1 tot 10 bar

Uitvoering:

Type MF:

Type MH:

Type MB:



Type MF - magnetisch - dubbelwerkend

Tech Data
60046

6710	Ø mm	Stroke mm	Mounting	Thread	Price	
MF0080010	8	10	M5	M12x1.25	M4x0.7	34.95
MF0080025	8	25	M5	M12x1.25	M4x0.7	36.55
MF0080050	8	50	M5	M12x1.25	M4x0.7	38.40
MF0080080	8	80	M5	M12x1.25	M4x0.7	39.30
MF0080100	8	100	M5	M12x1.25	M4x0.7	40.35
MF0080125	8	125	M5	M12x1.25	M4x0.7	41.90
MF0100010	10	10	M5	M12x1.25	M4x0.7	35.20
MF0100025	10	25	M5	M12x1.25	M4x0.7	37.00
MF0100050	10	50	M5	M12x1.25	M4x0.7	38.70
MF0100080	10	80	M5	M12x1.25	M4x0.7	39.60
MF0100100	10	100	M5	M12x1.25	M4x0.7	40.55
MF0100125	10	125	M5	M12x1.25	M4x0.7	42.85
MF0120010	12	10	M5	M16x1.5	M6x1	37.45
MF0120025	12	25	M5	M16x1.5	M6x1	38.10
MF0120050	12	50	M5	M16x1.5	M6x1	39.85
MF0120080	12	80	M5	M16x1.5	M6x1	40.60
MF0120100	12	100	M5	M16x1.5	M6x1	42.10
MF0120125	12	125	M5	M16x1.5	M6x1	43.25
MF0120160	12	160	M5	M16x1.5	M6x1	43.95
MF0120200	12	200	M5	M16x1.5	M6x1	45.70
MF0120250	12	250	M5	M16x1.5	M6x1	48.05
MF0160010	16	10	M5	M16x1.5	M6x1	39.30
MF0160025	16	25	M5	M16x1.5	M6x1	40.35
MF0160050	16	50	M5	M16x1.5	M6x1	41.90
MF0160080	16	80	M5	M16x1.5	M6x1	43.55
MF0160100	16	100	M5	M16x1.5	M6x1	44.20
MF0160125	16	125	M5	M16x1.5	M6x1	45.00
MF0160160	16	160	M5	M16x1.5	M6x1	47.65
MF0160200	16	200	M5	M16x1.5	M6x1	49.20
MF0160250	16	250	M5	M16x1.5	M6x1	51.10
MF0200010	20	10	1/8"	M22x1.5	M8x1.25	40.90
MF0200025	20	25	1/8"	M22x1.5	M8x1.25	41.90
MF0200050	20	50	1/8"	M22x1.5	M8x1.25	43.55
MF0200080	20	80	1/8"	M22x1.5	M8x1.25	45.85
MF0200100	20	100	1/8"	M22x1.5	M8x1.25	47.75
MF0200125	20	125	1/8"	M22x1.5	M8x1.25	48.45
MF0200160	20	160	1/8"	M22x1.5	M8x1.25	49.90
MF0200200	20	200	1/8"	M22x1.5	M8x1.25	53.30
MF0200250	20	250	1/8"	M22x1.5	M8x1.25	56.50
MF0200320	20	320	1/8"	M22x1.5	M8x1.25	59.75
MF0250010	25	10	1/8"	M22x1.5	M10x1.25	45.85
MF0250025	25	25	1/8"	M22x1.5	M10x1.25	46.70
MF0250050	25	50	1/8"	M22x1.5	M10x1.25	48.20
MF0250080	25	80	1/8"	M22x1.5	M10x1.25	49.90
MF0250100	25	100	1/8"	M22x1.5	M10x1.25	50.70
MF0250125	25	125	1/8"	M22x1.5	M10x1.25	53.30
MF0250160	25	160	1/8"	M22x1.5	M10x1.25	55.50
MF0250200	25	200	1/8"	M22x1.5	M10x1.25	59.00
MF0250250	25	250	1/8"	M22x1.5	M10x1.25	62.90
MF0250320	25	320	1/8"	M22x1.5	M10x1.25	68.15



Type MH - magnetisch - dubbelwerkend - instelbare buffering

Tech Data
60047

6710	Ø mm	Stroke mm	Mounting	Thread	Price	
MH0160025	16	25	M5	M16x1.5	M6x1	63.60
MH0160050	16	50	M5	M16x1.5	M6x1	64.80
MH0160080	16	80	M5	M16x1.5	M6x1	66.00
MH0160100	16	100	M5	M16x1.5	M6x1	67.30
MH0160125	16	125	M5	M16x1.5	M6x1	68.45
MH0160160	16	160	M5	M16x1.5	M6x1	70.80
MH0160200	16	200	M5	M16x1.5	M6x1	72.05
MH0160250	16	250	M5	M16x1.5	M6x1	73.55
MH0200025	20	25	1/8"	M22x1.5	M8x1.25	66.00
MH0200050	20	50	1/8"	M22x1.5	M8x1.25	68.40
MH0200080	20	80	1/8"	M22x1.5	M8x1.25	69.80
MH0200100	20	100	1/8"	M22x1.5	M8x1.25	70.90
MH0200125	20	125	1/8"	M22x1.5	M8x1.25	72.20
MH0200160	20	160	1/8"	M22x1.5	M8x1.25	73.55
MH0200200	20	200	1/8"	M22x1.5	M8x1.25	74.65
MH0200250	20	250	1/8"	M22x1.5	M8x1.25	75.95
MH0200320	20	320	1/8"	M22x1.5	M8x1.25	78.35
MH0250025	25	25	1/8"	M22x1.5	M10x1.25	72.20
MH0250050	25	50	1/8"	M22x1.5	M10x1.25	74.65
MH0250080	25	80	1/8"	M22x1.5	M10x1.25	75.95
MH0250100	25	100	1/8"	M22x1.5	M10x1.25	77.15
MH0250125	25	125	1/8"	M22x1.5	M10x1.25	78.35
MH0250160	25	160	1/8"	M22x1.5	M10x1.25	79.45
MH0250200	25	200	1/8"	M22x1.5	M10x1.25	80.95
MH0250250	25	250	1/8"	M22x1.5	M10x1.25	82.20
MH0250320	25	320	1/8"	M22x1.5	M10x1.25	84.85



Type MB - magnetisch - enkelwerkend

Tech Data
60048

6710	Ø mm	Stroke mm	Mounting	Thread	Price	
MB0080010	8	10	M5	M12x1.25	M4x0.7	34.75
MB0080025	8	25	M5	M12x1.25	M4x0.7	36.40
MB0080050	8	50	M5	M12x1.25	M4x0.7	38.20
MB0100010	10	10	M5	M12x1.25	M4x0.7	34.95
MB0100025	10	25	M5	M12x1.25	M4x0.7	36.65
MB0100050	10	50	M5	M12x1.25	M4x0.7	38.45
MB0120010	12	10	M5	M16x1.5	M6x1	37.25
MB0120025	12	25	M5	M16x1.5	M6x1	38.45
MB0120050	12	50	M5	M16x1.5	M6x1	39.65
MB0160010	16	10	M5	M16x1.5	M6x1	39.15
MB0160025	16	25	M5	M16x1.5	M6x1	40.15
MB0160050	16	50	M5	M16x1.5	M6x1	41.75
MB0200010	20	10	1/8"	M22x1.5	M8x1.25	40.65
MB0200025	20	25	1/8"	M22x1.5	M8x1.25	41.75
MB0200050	20	50	1/8"	M22x1.5	M8x1.25	43.40
MB0250010	25	10	1/8"	M22x1.5	M10x1.25	45.70
MB0250025	25	25	1/8"	M22x1.5	M10x1.25	46.50
MB0250050	25	50	1/8"	M22x1.5	M10x1.25	48.05

KELM™ pneumatiek
Hydrauliek
Snelkoppelingen
Afsluiters
Roestvast staal
Fittingen
Luchtconditionering
Gereedschap
Pneumatiek
Diversen
Malleabele fittingen & staal
Ringleidingssystemen
Slangen
Compressoren

ISO 6432 bevestigingen



Type MFL - flensbevestiging

6710		€
MFL008	8/10	3.85
MFL012	12/16	4.50
MFL020	20/25	6.35



Type MPD - bevestigingsvoet

6710		€
MPD008	8/10	3.85
MPD012	12/16	4.70
MPD020	20/25	4.90



Type MCC - scharnierbevestiging

6710		€
MCC008	8/10	5.70
MCC012	12/16	7.15
MCC020	20/25	7.40



Type DA - moer voor eindkap

6710			€
DAM12	8/10	M12x1.25	0.80
DAM16	12/16	M16x1.5	1.35
DAM22	20/25	M22x1.25	2.90



Type DA - moer voor zuigerstang

6710			€
DAM4	8/10	M4x0.7	0.05
DAM6	12/16	M6x1	0.05
DAM8	20	M8x1.25	0.25
DAM10	25	M10x1.25	0.25



Type FC - zuigerstang gaffel met pen

6710			€
FC008	8/10	M4x0.7	3.55
FC012	12/16	M6x1	2.95
FC020	20	M8x1.25	3.55
FC025	25	M10x1.25	4.50



Type TF - kogelstangkop - zelfsmrend

6710			€
TF008	8/10	M4x0.7	22.55
TF012	12/16	M6x1	18.45
TF020	20	M8x1.25	19.00
TF025	25	M10x1.25	20.35

KELM™
pneumatiek

Hydrauliek

Snel-
koppelingen

Afsluiters

Roestvast
staal

Fittingen

Lucht-
conditionering

Gereedschap

Pneumatiek

Diversen

Malleabele
fittingen
& staal

Ringleiding-
systemen

Slangen

Compressoren

ISO 6432 RVS rondcilinders

RVS

Tech Data
60050

Medium:

Gefilterde, gesmeerde en ongesmeerde perslucht

Materiaal: Cilinderbuis: RVS AISI-304

Zuigerstang: RVS AISI-316

Kappen: RVS AISI-304

Dichting: NBR/PU

Uitvoering:



Temperatuur:
0°C tot 80°C

Maximale werkdruk:
2 tot 10 bar



Type MFI - magnetisch - dubbelwerkend

6710					€	
MFIO160010	16	10	M5	M16x1.5	M6x1	105.30
MFIO160025	16	25	M5	M16x1.5	M6x1	106.00
MFIO160050	16	50	M5	M16x1.5	M6x1	107.20
MFIO160080	16	80	M5	M16x1.5	M6x1	108.60
MFIO160100	16	100	M5	M16x1.5	M6x1	109.50
MFIO160125	16	125	M5	M16x1.5	M6x1	110.70
MFIO160160	16	160	M5	M16x1.5	M6x1	113.05
MFIO160200	16	200	M5	M16x1.5	M6x1	114.85
MFIO160250	16	250	M5	M16x1.5	M6x1	117.20
MFIO160320	16	320	M5	M16x1.5	M6x1	120.45
MFIO200010	20	10	1/8"	M22x1.5	M8x1.25	121.05
MFIO200025	20	25	1/8"	M22x1.5	M8x1.25	121.80
MFIO200050	20	50	1/8"	M22x1.5	M8x1.25	123.15
MFIO200080	20	80	1/8"	M22x1.5	M8x1.25	124.70
MFIO200100	20	100	1/8"	M22x1.5	M8x1.25	125.80
MFIO200125	20	125	1/8"	M22x1.5	M8x1.25	127.10
MFIO200160	20	160	1/8"	M22x1.5	M8x1.25	129.85
MFIO200200	20	200	1/8"	M22x1.5	M8x1.25	132.00
MFIO200250	20	250	1/8"	M22x1.5	M8x1.25	134.70
MFIO200320	20	320	1/8"	M22x1.5	M8x1.25	138.40
MFIO250010	25	10	1/8"	M22x1.5	M10x1.25	128.25
MFIO250025	25	25	1/8"	M22x1.5	M10x1.25	129.40
MFIO250050	25	50	1/8"	M22x1.5	M10x1.25	131.45
MFIO250080	25	80	1/8"	M22x1.5	M10x1.25	133.70
MFIO250100	25	100	1/8"	M22x1.5	M10x1.25	135.25
MFIO250125	25	125	1/8"	M22x1.5	M10x1.25	137.20
MFIO250160	25	160	1/8"	M22x1.5	M10x1.25	140.95
MFIO250200	25	200	1/8"	M22x1.5	M10x1.25	144.05
MFIO250250	25	250	1/8"	M22x1.5	M10x1.25	147.90
MFIO250320	25	320	1/8"	M22x1.5	M10x1.25	153.45

ISO 6432 RVS bevestigingen

RVS

Tech Data
60051



Type MFLI - flensbevestiging

6710		€
MFLI016	16	11.50
MFLI020	20/25	19.30



Type MPDI - bevestigingsvoet

6710		€
MPDI016	16	12.30
MPDI020	20/25	21.85



Type MCCI - scharnierbevestiging

6710		€
MCCI016	16	20.15
MCCI020	20/25	27.40



Type DAI - moer voor eindkap

6710			€
DASSM16	16	M16x1.5	3.95
DASSM22	20/25	M22x1.5	5.25

Type DAI - moer voor zuigerstang

6710			€
DASSM6	16	M6x1	0.10
DASSM8	20	M8x1.25	1.60
DASSM10	25	M10x1.25	1.75

ISO 15552 cilinders

Medium:

Gefilterde, gesmeerde en ongesmeerde perslucht

Materiaal: Cilinderbuis: geanodiseerd aluminium

Zuigerstang: verchroomd staal

Kappen: aluminium

Dichting: NBR/PU



Temperatuur:

0°C tot +80°C
(-20°C bij droge lucht)



Maximale werkdruk:

1 tot 10 bar

Uitvoering:

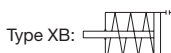
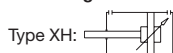

Type XH - magnetisch - dubbelwerkend - instelbare buffering

6710					€
XH0320025	32	25	1/8"	M10x1.25	82.20
XH0320050	32	50	1/8"	M10x1.25	84.35
XH0320075	32	75	1/8"	M10x1.25	86.65
XH0320080	32	80	1/8"	M10x1.25	87.00
XH0320100	32	100	1/8"	M10x1.25	89.30
XH0320125	32	125	1/8"	M10x1.25	91.55
XH0320150	32	150	1/8"	M10x1.25	93.80
XH0320160	32	160	1/8"	M10x1.25	94.70
XH0320200	32	200	1/8"	M10x1.25	98.10
XH0320250	32	250	1/8"	M10x1.25	101.85
XH0320300	32	300	1/8"	M10x1.25	106.60
XH0320320	32	320	1/8"	M10x1.25	108.55
XH0320350	32	350	1/8"	M10x1.25	111.40
XH0320400	32	400	1/8"	M10x1.25	116.15
XH0320450	32	450	1/8"	M10x1.25	122.50
XH0320500	32	500	1/8"	M10x1.25	128.00
XH0320600	32	600	1/8"	M10x1.25	138.85
XH0320700	32	700	1/8"	M10x1.25	149.85
XH0320800	32	800	1/8"	M10x1.25	160.75
XH0320900	32	900	1/8"	M10x1.25	171.70
XH0321000	32	1000	1/8"	M10x1.25	182.30
XH0400025	40	25	1/4"	M12x1.25	93.65
XH0400050	40	50	1/4"	M12x1.25	96.40
XH0400075	40	75	1/4"	M12x1.25	99.15
XH0400080	40	80	1/4"	M12x1.25	99.70
XH0400100	40	100	1/4"	M12x1.25	101.90
XH0400125	40	125	1/4"	M12x1.25	104.70
XH0400150	40	150	1/4"	M12x1.25	107.45
XH0400160	40	160	1/4"	M12x1.25	108.50
XH0400200	40	200	1/4"	M12x1.25	112.85
XH0400250	40	250	1/4"	M12x1.25	118.35
XH0400300	40	300	1/4"	M12x1.25	125.45
XH0400320	40	320	1/4"	M12x1.25	128.25
XH0400350	40	350	1/4"	M12x1.25	132.20
XH0400400	40	400	1/4"	M12x1.25	138.90
XH0400450	40	450	1/4"	M12x1.25	145.70
XH0400500	40	500	1/4"	M12x1.25	152.50
XH0400600	40	600	1/4"	M12x1.25	166.15
XH0400700	40	700	1/4"	M12x1.25	180.15
XH0400800	40	800	1/4"	M12x1.25	194.05
XH0400900	40	900	1/4"	M12x1.25	207.95
XH0401000	40	1000	1/4"	M12x1.25	221.55
XH0500025	50	25	1/4"	M16x1.5	111.55
XH0500050	50	50	1/4"	M16x1.5	115.20
XH0500075	50	75	1/4"	M16x1.5	118.80
XH0500080	50	80	1/4"	M16x1.5	119.50
XH0500100	50	100	1/4"	M16x1.5	122.35
XH0500125	50	125	1/4"	M16x1.5	126.05
XH0500150	50	150	1/4"	M16x1.5	129.70
XH0500160	50	160	1/4"	M16x1.5	131.00

6710					€
XH05000200	50	200	1/4"	M16x1.5	137.55
XH05000250	50	250	1/4"	M16x1.5	145.90
XH05000300	50	300	1/4"	M16x1.5	154.15
XH05000320	50	320	1/4"	M16x1.5	157.20
XH05000350	50	350	1/4"	M16x1.5	162.15
XH05000400	50	400	1/4"	M16x1.5	170.50
XH05000450	50	450	1/4"	M16x1.5	178.80
XH05000500	50	500	1/4"	M16x1.5	187.20
XH05000600	50	600	1/4"	M16x1.5	204.00
XH05000700	50	700	1/4"	M16x1.5	221.00
XH05000800	50	800	1/4"	M16x1.5	237.85
XH05000900	50	900	1/4"	M16x1.5	254.80
XH0501000	50	1000	1/4"	M16x1.5	271.35
XH06300025	63	25	3/8"	M16x1.5	132.70
XH06300050	63	50	3/8"	M16x1.5	136.45
XH06300075	63	75	3/8"	M16x1.5	140.35
XH06300080	63	80	3/8"	M16x1.5	141.10
XH06300100	63	100	3/8"	M16x1.5	144.10
XH06300125	63	125	3/8"	M16x1.5	150.35
XH06300150	63	150	3/8"	M16x1.5	154.95
XH06300160	63	160	3/8"	M16x1.5	156.85
XH06300200	63	200	3/8"	M16x1.5	163.35
XH06300250	63	250	3/8"	M16x1.5	172.60
XH06300300	63	300	3/8"	M16x1.5	181.90
XH06300320	63	320	3/8"	M16x1.5	185.35
XH06300350	63	350	3/8"	M16x1.5	191.10
XH06300400	63	400	3/8"	M16x1.5	200.40
XH06300450	63	450	3/8"	M16x1.5	209.60
XH06300500	63	500	3/8"	M16x1.5	218.95
XH06300600	63	600	3/8"	M16x1.5	237.30
XH06300700	63	700	3/8"	M16x1.5	255.65
XH06300800	63	800	3/8"	M16x1.5	274.15
XH06300900	63	900	3/8"	M16x1.5	292.65
XH0631000	63	1000	3/8"	M16x1.5	310.55
XH08000025	80	25	3/8"	M20x1.5	170.20
XH08000050	80	50	3/8"	M20x1.5	175.50
XH08000075	80	75	3/8"	M20x1.5	180.85
XH08000080	80	80	3/8"	M20x1.5	181.90
XH08000100	80	100	3/8"	M20x1.5	187.20
XH08000125	80	125	3/8"	M20x1.5	196.30
XH08000150	80	150	3/8"	M20x1.5	203.10
XH08000160	80	160	3/8"	M20x1.5	205.80
XH08000200	80	200	3/8"	M20x1.5	216.70
XH08000250	80	250	3/8"	M20x1.5	230.50
XH08000300	80	300	3/8"	M20x1.5	244.20
XH08000320	80	320	3/8"	M20x1.5	249.50
XH08000350	80	350	3/8"	M20x1.5	258.00
XH08000400	80	400	3/8"	M20x1.5	271.80
XH08000450	80	450	3/8"	M20x1.5	285.60
XH08000500	80	500	3/8"	M20x1.5	299.45

- KELM™ pneumatiek
- Hydrauliek
- Snelkoppelingen
- Afsluiters
- Roestvast staal
- Fittingen
- Luchtconditionering
- Gereedschap
- Pneumatiek
- Diversen
- Malleabele fittingen & staal
- Ringleidingssystemen
- Slangen
- Compressoren

ISO 15552 cilinders

Medium:

Gefilterde, gesmeerde en ongesmeerde perslucht

Materiaal: Cilinderbuis: geanodiseerd aluminium

Zuigerstang: verchroomd staal

Kappen: aluminium

Dichting: NBR/PU

Uitvoering:

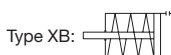
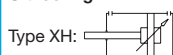

Tech Data
60052

Tech Data
60053

Type XH - magnetisch - dubbelwerkend - instelbare buffering

6710					€
XH0800600	80	600	3/8"	M20x1.5	326.75
XH0800700	80	700	3/8"	M20x1.5	354.20
XH0800800	80	800	3/8"	M20x1.5	381.65
XH0800900	80	900	3/8"	M20x1.5	409.15
XH0801000	80	1000	3/8"	M20x1.5	436.05
XH1000025	100	25	1/2"	M20x1.5	204.00
XH1000050	100	50	1/2"	M20x1.5	210.40
XH1000075	100	75	1/2"	M20x1.5	216.75
XH1000080	100	80	1/2"	M20x1.5	218.05
XH1000100	100	100	1/2"	M20x1.5	224.45
XH1000125	100	125	1/2"	M20x1.5	230.75
XH1000150	100	150	1/2"	M20x1.5	237.15
XH1000160	100	160	1/2"	M20x1.5	239.75
XH1000200	100	200	1/2"	M20x1.5	250.20
XH1000250	100	250	1/2"	M20x1.5	263.55
XH1000300	100	300	1/2"	M20x1.5	276.90
XH1000320	100	320	1/2"	M20x1.5	282.15
XH1000350	100	350	1/2"	M20x1.5	290.30
XH1000400	100	400	1/2"	M20x1.5	303.60
XH1000450	100	450	1/2"	M20x1.5	317.00
XH1000500	100	500	1/2"	M20x1.5	331.05
XH1000600	100	600	1/2"	M20x1.5	358.35
XH1000700	100	700	1/2"	M20x1.5	385.70
XH1000800	100	800	1/2"	M20x1.5	412.95
XH1000900	100	900	1/2"	M20x1.5	440.25
XH1001000	100	1000	1/2"	M20x1.5	467.45
XH1250025	125	25	1/2"	M27x2	324.15
XH1250050	125	50	1/2"	M27x2	332.05
XH1250075	125	75	1/2"	M27x2	340.00
XH1250080	125	80	1/2"	M27x2	341.40
XH1250100	125	100	1/2"	M27x2	348.05
XH1250125	125	125	1/2"	M27x2	356.00
XH1250150	125	150	1/2"	M27x2	363.90
XH1250160	125	160	1/2"	M27x2	367.25
XH1250200	125	200	1/2"	M27x2	380.60
XH1250250	125	250	1/2"	M27x2	397.50
XH1250300	125	300	1/2"	M27x2	414.50
XH1250320	125	320	1/2"	M27x2	421.50
XH1250350	125	350	1/2"	M27x2	431.45
XH1250400	125	400	1/2"	M27x2	449.65
XH1250450	125	450	1/2"	M27x2	468.60
XH1250500	125	500	1/2"	M27x2	487.55
XH1250600	125	600	1/2"	M27x2	525.70
XH1250700	125	700	1/2"	M27x2	563.90
XH1250800	125	800	1/2"	M27x2	601.95
XH1250900	125	900	1/2"	M27x2	640.15
XH1251000	125	1000	1/2"	M27x2	677.80

Type XB - magnetisch - enkelwerkend

6710					€
XB0320025	32	25	1/8"	M10x1.25	106.80
XB0320050	32	50	1/8"	M10x1.25	109.65
XB0320075	32	75	1/8"	M10x1.25	112.65
XB0320080	32	80	1/8"	M10x1.25	113.15
XB0320100	32	100	1/8"	M10x1.25	116.00
XB0400025	40	25	1/4"	M12x1.25	121.80
XB0400050	40	50	1/4"	M12x1.25	125.25
XB0400075	40	75	1/4"	M12x1.25	128.90
XB0400080	40	80	1/4"	M12x1.25	129.60
XB0400100	40	100	1/4"	M12x1.25	132.50
XB0500025	50	25	1/4"	M16x1.5	145.00
XB0500050	50	50	1/4"	M16x1.5	149.60
XB0500075	50	75	1/4"	M16x1.5	154.45
XB0500080	50	80	1/4"	M16x1.5	155.40
XB0500100	50	100	1/4"	M16x1.5	159.10
XB0630025	63	25	3/8"	M16x1.5	172.50
XB0630050	63	50	3/8"	M16x1.5	177.55
XB0630075	63	75	3/8"	M16x1.5	182.40
XB0630080	63	80	3/8"	M16x1.5	183.45
XB0630100	63	100	3/8"	M16x1.5	187.40
XB0800025	80	25	3/8"	M20x1.5	221.25
XB0800050	80	50	3/8"	M20x1.5	228.10
XB0800075	80	75	3/8"	M20x1.5	235.10
XB0800080	80	80	3/8"	M20x1.5	236.45
XB0800100	80	100	3/8"	M20x1.5	243.35
XB1000025	100	25	1/2"	M20x1.5	265.20
XB1000050	100	50	1/2"	M20x1.5	273.45
XB1000075	100	75	1/2"	M20x1.5	281.80
XB1000080	100	80	1/2"	M20x1.5	283.45
XB1000100	100	100	1/2"	M20x1.5	291.70

KELM™ pneumatiek
Hydrauliek
Snel- koppelingen
Afsluiters
Roestvast staal
Fittingen
Lucht- conditionering
Gereedschap
Pneumatiek
Diversen
Malleabele fittingen & staal
Ringleiding- systemen
Slangen
Compressoren

ISO 15552 bevestigingen



Type VFL - flensbevestiging

6710	Ø mm	€
VFL032	32	24.25
VFL040	40	29.85
VFL050	50	32.50
VFL063	63	43.55
VFL080	80	56.65
VFL100	100	67.80
VFL125	125	164.10



Type VCP - bevestigingsvoet

6710	Ø mm	€
VCP032	32	8.95
VCP040	40	10.40
VCP050	50	12.65
VCP063	63	14.00
VCP080	80	20.30
VCP100	100	29.90
VCP125	125	120.15



Type VCF - dubbel achterscharnier - zelfmerend

6710	Ø mm	€
VCF032	32	19.85
VCF040	40	22.75
VCF050	50	25.30
VCF063	63	31.50
VCF080	80	39.35
VCF100	100	55.05
VCF125	125	109.15



Type VCM - enkel achterscharnier

6710	Ø mm	€
VCM032	32	18.80
VCM040	40	20.50
VCM050	50	22.90
VCM063	63	28.50
VCM080	80	35.50
VCM100	100	49.50
VCM125	125	85.80



Type VCH - dubbel achterscharnier

6710	Ø mm	€
VCH032	32	16.85
VCH040	40	18.30
VCH050	50	21.45
VCH063	63	26.35
VCH080	80	33.60
VCH100	100	46.85
VCH125	125	81.95



Type VCNT - zwenktapbevestiging voor

6710	Ø mm	€
VCNT032	32	61.85
VCNT040	40	67.75
VCNT050	50	78.80
VCNT063	63	105.35
VCNT080	80	121.45
VCNT100	100	168.95
VCNT125	125	291.85

ISO 15552 bevestigingen



Type VSI - zwenktapesteun

6710		€
VSI032	32	56.65
VSI040	40/50	59.20
VSI063	63/80	67.50
VSI100	100/125	74.25



Type VAS - bevestigingssteun achter

6710		€
VAS032	32	18.85
VAS040	40	26.45
VAS050	50	28.20
VAS063	63	40.50
VAS080	80	42.40
VAS100	100	65.05
VAS125	125	75.35



Type VPE - pen

6710		€
VPE032	32	3.10
VPE040	40	4.40
VPE050	50	4.55
VPE063	63	5.05
VPE080	80	5.60
VPE100	100	8.25
VPE125	125	10.60



Type FC - zuigerstang gaffel met pen

6710			€
FC025	25/32	M10x1.25	4.50
FC040	40	M12x1.25	7.30
FC050	50/63	M16x1.5	14.95
FC080	80/100	M20x1.5	27.15
FC125	125	M27x2	96.35



Type TF - kogelstangkop - zelfmerend

6710			€
TF025	25/32	M10x1.25	20.35
TF040	40	M12x1.25	30.25
TF050	50/63	M16x1.5	49.15
TF080	80/100	M20x1.5	83.45
TF125	125	M27x2	230.35



Type TS - uitlijnkop

6710			€
TS025	25/32	M10x1.25	52.85
TS040	40	M12x1.25	63.60
TS050	50/63	M16x1.5	85.15
TS080	80/100	M20x1.5	121.70



Type DA - moer voor zuigerstang

6710			€
DAM10	25/32	M10x1.25	0.25
DAM12	40	M12x1.25	0.80
DAM16	50/63	M16x1.5	1.35
DAM20	80/100	M20x1.5	1.80
DAM27	125	M27x2	3.25

Perslucht cilinders



Compactcilinders

Medium:

Gefilterde, gesmeerde en ongesmeerde perslucht

Materiaal: Cilinderbuis: geanodiseerd aluminium

Zuigerstang: RVS AISI-303 (boring 12 tot 25)
en verchroomd staal (boring 32 tot 100)

Kappen: geanodiseerd aluminium

Dichting: NBR/PU

Temperatuur:
0°C tot +80°C
(-20°C bij droge lucht)

Maximale werkdruk:
1 tot 10 bar

Uitvoering: Type QB:  Type QF: 

Type QB - magnetisch -
enkelwerkend

Tech Data
60055

6710	Ø mm	Stroke mm	Thread	Rod Thread	€
QB0120005	12	5	M5	M3	52.55
QB0120010	12	10	M5	M3	52.95
QB0160005	16	5	M5	M4	53.50
QB0160010	16	10	M5	M4	53.90
QB0160015	16	15	M5	M4	54.25
QB0160020	16	20	M5	M4	54.65
QB0160025	16	25	M5	M4	55.00
QB0200005	20	5	M5	M5	59.05
QB0200010	20	10	M5	M5	59.50
QB0200015	20	15	M5	M5	60.00
QB0200020	20	20	M5	M5	60.40
QB0200025	20	25	M5	M5	60.90
QB0250005	25	5	M5	M5	60.00
QB0250010	25	10	M5	M5	60.40
QB0250015	25	15	M5	M5	60.90
QB0250020	25	20	M5	M5	61.35
QB0250025	25	25	M5	M5	61.85
QB0320005	32	5	1/8"	M6	65.50
QB0320010	32	10	1/8"	M6	66.25
QB0320015	32	15	1/8"	M6	67.00
QB0320020	32	20	1/8"	M6	67.75
QB0320025	32	25	1/8"	M6	68.45
QB0400005	40	5	1/8"	M6	84.50
QB0400010	40	10	1/8"	M6	85.95
QB0400015	40	15	1/8"	M6	87.30
QB0400020	40	20	1/8"	M6	88.70
QB0400025	40	25	1/8"	M6	90.05
QB0500005	50	5	1/8"	M8	97.80
QB0500010	50	10	1/8"	M8	99.50
QB0500015	50	15	1/8"	M8	101.10
QB0500020	50	20	1/8"	M8	102.80
QB0500025	50	25	1/8"	M8	104.45
QB0630005	63	5	1/8"	M8	122.75
QB0630010	63	10	1/8"	M8	124.95
QB0630015	63	15	1/8"	M8	127.20
QB0630020	63	20	1/8"	M8	129.40
QB0630025	63	25	1/8"	M8	131.60
QB0800005	80	5	1/8"	M10	152.05
QB0800010	80	10	1/8"	M10	155.35
QB0800015	80	15	1/8"	M10	158.55
QB0800020	80	20	1/8"	M10	161.80
QB0800025	80	25	1/8"	M10	165.05
QB1000005	100	5	1/8"	M12	193.80
QB1000010	100	10	1/8"	M12	197.95
QB1000015	100	15	1/8"	M12	202.15
QB1000020	100	20	1/8"	M12	206.25
QB1000025	100	25	1/8"	M12	210.40

Type QF - magnetisch -
dubbelwerkend

Tech Data
60056

6710	Ø mm	Stroke mm	Thread	Rod Thread	€
QF0120005	12	5	M5	M3	52.55
QF0120010	12	10	M5	M3	52.95
QF0120015	12	15	M5	M3	53.35
QF0120020	12	20	M5	M3	53.75
QF0120025	12	25	M5	M3	54.10
QF0120030	12	30	M5	M3	54.45
QF0120040	12	40	M5	M3	55.15
QF0160005	16	5	M5	M4	53.50
QF0160010	16	10	M5	M4	53.90
QF0160015	16	15	M5	M4	54.25
QF0160020	16	20	M5	M4	54.65
QF0160025	16	25	M5	M4	55.00
QF0160030	16	30	M5	M4	55.35
QF0160040	16	40	M5	M4	56.10
QF0200005	20	5	M5	M5	59.05
QF0200010	20	10	M5	M5	59.50
QF0200015	20	15	M5	M5	60.00
QF0200020	20	20	M5	M5	60.40
QF0200025	20	25	M5	M5	60.90
QF0200030	20	30	M5	M5	61.35
QF0200040	20	40	M5	M5	62.30
QF0200050	20	50	M5	M5	63.15
QF0250005	25	5	M5	M5	60.00
QF0250010	25	10	M5	M5	60.40
QF0250015	25	15	M5	M5	60.90
QF0250020	25	20	M5	M5	61.35
QF0250025	25	25	M5	M5	61.85
QF0250030	25	30	M5	M5	62.30
QF0250040	25	40	M5	M5	63.15
QF0250050	25	50	M5	M5	64.10
QF0320005	32	5	1/8"	M6	65.50
QF0320010	32	10	1/8"	M6	66.25
QF0320015	32	15	1/8"	M6	67.00
QF0320020	32	20	1/8"	M6	67.75
QF0320025	32	25	1/8"	M6	68.45
QF0320030	32	30	1/8"	M6	69.15
QF0320040	32	40	1/8"	M6	70.70
QF0320050	32	50	1/8"	M6	72.20
QF0320060	32	60	1/8"	M6	73.65
QF0320080	32	80	1/8"	M6	76.60
QF0320100	32	100	1/8"	M6	79.55
QF0320125	32	125	1/8"	M6	83.25
QF0320150	32	150	1/8"	M6	86.90
QF0400005	40	5	1/8"	M6	84.50
QF0400010	40	10	1/8"	M6	85.95
QF0400015	40	15	1/8"	M6	87.30
QF0400020	40	20	1/8"	M6	88.70
QF0400025	40	25	1/8"	M6	90.05
QF0400030	40	30	1/8"	M6	91.45
QF0400040	40	40	1/8"	M6	94.25
QF0400050	40	50	1/8"	M6	97.00
QF0400060	40	60	1/8"	M6	99.80
QF0400080	40	80	1/8"	M6	105.30
QF0400100	40	100	1/8"	M6	110.80
QF0400125	40	125	1/8"	M6	117.70
QF0400150	40	150	1/8"	M6	124.70



6710	Ø mm	Stroke mm	Thread	Rod Thread	€
QF0500005	50	5	1/8"	M8	97.80
QF0500010	50	10	1/8"	M8	99.50
QF0500015	50	15	1/8"	M8	101.10
QF0500020	50	20	1/8"	M8	102.80
QF0500025	50	25	1/8"	M8	104.45
QF0500030	50	30	1/8"	M8	106.10
QF0500040	50	40	1/8"	M8	109.45
QF0500050	50	50	1/8"	M8	112.85
QF0500060	50	60	1/8"	M8	116.10
QF0500080	50	80	1/8"	M8	122.75
QF0500100	50	100	1/8"	M8	129.40
QF0500125	50	125	1/8"	M8	137.70
QF0500150	50	150	1/8"	M8	146.00
QF0500200	50	200	1/8"	M8	162.60
QF0630005	63	5	1/8"	M8	122.75
QF0630010	63	10	1/8"	M8	124.95
QF0630015	63	15	1/8"	M8	127.20
QF0630020	63	20	1/8"	M8	129.40
QF0630025	63	25	1/8"	M8	131.60
QF0630030	63	30	1/8"	M8	133.75
QF0630040	63	40	1/8"	M8	138.25
QF0630050	63	50	1/8"	M8	142.65
QF0630060	63	60	1/8"	M8	147.05
QF0630080	63	80	1/8"	M8	155.95
QF0630100	63	100	1/8"	M8	164.80
QF0630125	63	125	1/8"	M8	175.90
QF0630150	63	150	1/8"	M8	187.00
QF0630200	63	200	1/8"	M8	209.15
QF0800005	80	5	1/8"	M10	152.05
QF0800010	80	10	1/8"	M10	155.35
QF0800015	80	15	1/8"	M10	158.55
QF0800020	80	20	1/8"	M10	161.80
QF0800025	80	25	1/8"	M10	165.05
QF0800030	80	30	1/8"	M10	168.20
QF0800040	80	40	1/8"	M10	174.75
QF0800050	80	50	1/8"	M10	181.15
QF0800060	80	60	1/8"	M10	187.55
QF0800080	80	80	1/8"	M10	200.50
QF0800100	80	100	1/8"	M10	213.50
QF0800125	80	125	1/8"	M10	229.65
QF0800150	80	150	1/8"	M10	245.80
QF0800200	80	200	1/8"	M10	278.10
QF1000005	100	5	1/4"	M12	193.80
QF1000010	100	10	1/4"	M12	197.95
QF1000015	100	15	1/4"	M12	202.15
QF1000020	100	20	1/4"	M12	206.25
QF1000025	100	25	1/4"	M12	210.40
QF1000030	100	30	1/4"	M12	214.55
QF1000040	100	40	1/4"	M12	222.85
QF1000050	100	50	1/4"	M12	231.20
QF1000060	100	60	1/4"	M12	239.45
QF1000080	100	80	1/4"	M12	256.15
QF1000100	100	100	1/4"	M12	272.75
QF1000125	100	125	1/4"	M12	293.50
QF1000150	100	150	1/4"	M12	314.25
QF1000200	100	200	1/4"	M12	355.85

KELM™
pneumatiek

Hydrauliek

Snel-
koppelingen

Afsluiters

Roestvast
staal

Fittingen

Lucht-
conditionering

Gereedschap

Pneumatiek

Diversen

Malleabele
fittingen
& staal

Ringleiding-
systemen

Slangen

Compressoren

Compactcilinders bevestigingen



Type QFL - flensbevestiging

6710	Ø mm	€
QFL012	12/16	18.80
QFL020	20	20.45
QFL025	25	21.45
QFL032	32	24.70
QFL040	40	28.10
QFL050	50	31.75
QFL063	63	43.90
QFL080	80	57.75
QFL100	100	67.10



Type QCP - bevestigingsvoet

6710	Ø mm	€
QCP012	12/16	5.90
QCP020	20	6.65
QCP025	25	6.65
QCP032	32	8.20
QCP040	40	9.65
QCP050	50	11.50
QCP063	63	13.95
QCP080	80	19.50
QCP100	100	25.50



Type QCM - enkel achterscharnier - zelfsmarend

6710	Ø mm	€
QCM012	12/16	16.60
QCM020	20	17.95
QCM025	25	19.40



Type QCF - dubbel achterscharnier - zelfsmarend

6710	Ø mm	€
QCF032	32	25.30
QCF040	40	29.05
QCF050	50	31.75
QCF063	63	38.35
QCF080	80	48.35
QCF100	100	67.50



Type VAS - bevestigingssteun achter

6710	Ø mm	€
VAS032	32	18.85
VAS040	40	26.45
VAS050	50	28.20
VAS063	63	40.50
VAS080	80	42.40
VAS100	100	65.05



Type VPE - pen

6710	Ø mm	€
VPE032	32	3.10
VPE040	40	4.40
VPE050	50	4.55
VPE063	63	5.05
VPE080	80	5.60
VPE100	100	8.25



Type TM - kogelstangkop male

6710	Ø mm	€	
TM020	20/25	M5x0.8	20.95
TM032	32/40	M6x1	19.85
TM050	50/63	M8x1.25	22.75
TM080	80	M10x1.5	25.60
TM100	100	M12x1.75	29.45

Magneetschakelaars

Geschikt voor gebruik met Aignep ISO 6432 rondcilinders, ISO 15552 cilinders en compactcilinders.

Temperatuur:
-20°C tot +70°C

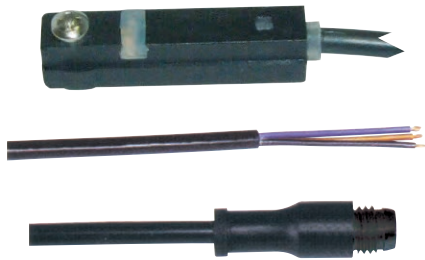

Type DSL - profielbevestiging (lengterichting)

6710					€
DSL1C225	Reed	3-130V AC/DC	2.5M	kabel (2-draads)	29.60
DSL1M8	Reed	3-130V AC/DC	0.3M	M8	33.65
DSL4N225	Hall/PNP	10/30V AC/DC	2.5M	kabel (3-draads)	44.80
DSL4M8	Hall/PNP	10/30V AC/DC	0.3M	M8	42.80



Type MFX - montagebeugel voor ISO 6432 rondcilinders

6710		€
MFX008	8	2.75
MFX010	10	2.75
MFX012	12	2.75
MFX016	16	2.75
MFX020	20	2.75
MFX025	25	2.75

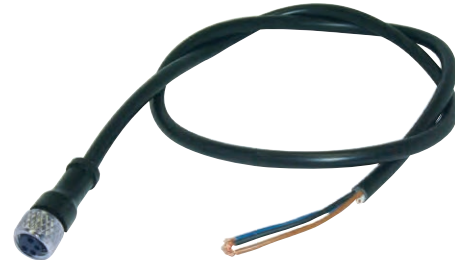

Type PX - verlengkabel

6710		€
PX5000	5M	18.10

KELM™
pneumatiek

Hydrauliek

Snel-
koppelingen

Afsluiters

Roestvast
staal

Fittingen

Lucht-
conditionering

Gereedschap

Pneumatiek

Diversen

Malleabele
fittingen
& staal

Ringleiding-
systemen

Slangen

Compressoren

Flowregelaars

Flowregelaars met geïntegreerde functie

Geschikt voor perslucht, overdruk en vacuüm.

Toepassing: Flowregelaars worden op cilinders of ventielen gebouwd om de snelheid van de slag van de cilinder (uitgaand, ingaand of beide) goed in te regelen. Flowregelaars worden als smoorregeling toegepast. Het beste resultaat wordt verkregen door de uitgaande luchtstroom te smoren, waardoor schokkend werken van de cilinder wordt voorkomen.

Temperatuur:
-20°C tot 80°C

Maximale werkdruk:
1 tot 10 bar *

*** Attentie:** De drukgegevens zijn gebaseerd op een temperatuur van 20°C. Veiligheidsfactor = 3
Bij temperatuurverhoging daalt de werkdruk met een variabele factor, zie tabel PA.
Voor correcte werking is minimaal een druk nodig van 1 Bar

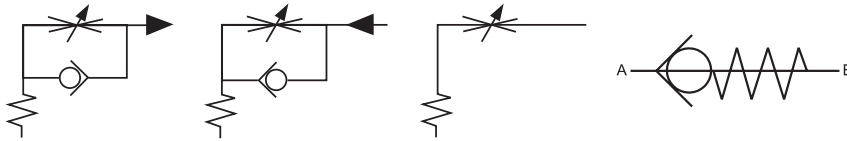

Flowregelaar - afvoer

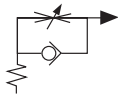

Enriching - verzonken regelschroef

	MRK			H mm	€
90090500		M5	8	24	10.20
90091000		1/8"	14	30.5	7.50
90091300		1/4"	17	36	8.25

Flowregelaar - toevoer

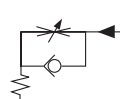

Enriching - verzonken regelschroef

	MRK			H mm	€
90110500		M5	8	24	10.20
90111000		1/8"	14	30.5	7.50
90111300		1/4"	17	35.5	8.25

Flowregelaar - bidirectioneel

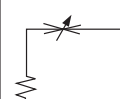

Tweerichting - verzonken regelschroef

	MRK			H mm	€
90120500		M5	8	24	7.70
90121000		1/8"	14	30.5	5.60
90121300		1/4"	17	35.5	6.35

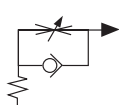

Enriching - uitwendige regelschroef

	MRK			H mm	€
90350500		M5	8	35	11.45
90351000		1/8"	14	45	8.25
90351300		1/4"	17	51.5	9.25

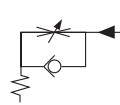

Enriching - uitwendige regelschroef

	MRK			H mm	€
90360500		M5	8	35	11.45
90361000		1/8"	14	45	8.25
90361300		1/4"	17	51.5	9.45

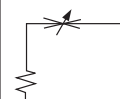

Tweerichting - uitwendige regelschroef

	MRK			H mm	€
90370500		M5	8	35	8.40
90371000		1/8"	14	45	6.75
90371300		1/4"	17	51.5	7.15

Flowregelaars

Flowregelaar - terugslagklep



Niet instelbaar - stroomrichting van bout naar huis

MRK	Symbol	Symbol	H mm	€
90381000	1/8"	14	32.5	11.70
90381300	1/4"	17	35	12.15



Niet instelbaar - stroomrichting van huis naar bout

MRK	Symbol	Symbol	H mm	€
90391000	1/8"	14	32.5	11.70
90391300	1/4"	17	35	12.85

Flowregelaar opsteek - afvoer

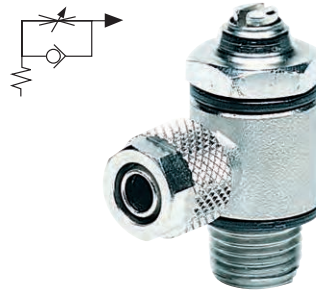

Eenrichting - verzonken regelschroef

MRK	Symbol	Symbol	H mm	€
90020405	4 x M5	8	24	12.80
90020410	4 x 1/8"	14	30.5	10.40
90020605	6 x M5	8	26	12.65
90020610	6 x 1/8"	14	31	10.60
90020613	6 x 1/4"	17	36	11.45
90020810	8 x 1/8"	14	31	10.60
90020813	8 x 1/4"	17	36	11.55
90021013	10 x 1/4"	17	36	11.30

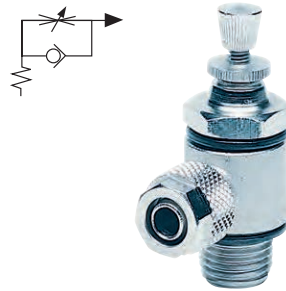

Eenrichting - uitwendige regelschroef

MRK	Symbol	Symbol	H mm	€
91020405	4 x M5	8	35	13.35
91020410	4 x 1/8"	14	45	10.75
91020605	6 x M5	8	35	13.35
91020610	6 x 1/8"	14	45	10.85
91020613	6 x 1/4"	17	52	11.95
91020810	8 x 1/8"	14	45	10.85
91020813	8 x 1/4"	17	52	12.15
91021013	10 x 1/4"	17	52	12.25

Flowregelaar opsteek (POM) - afvoer

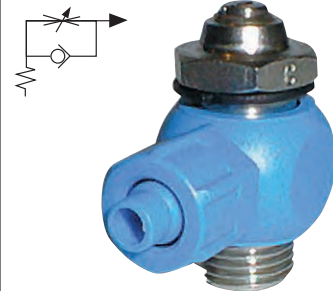

Eenrichting - verzonken regelschroef

MRK	Symbol	Symbol	H mm	€
90040610	6 x 1/8"	14	31	8.90
90040613	6 x 1/4"	17	36	9.70
90040810	8 x 1/8"	14	31	8.90
90040813	8 x 1/4"	17	36	9.80

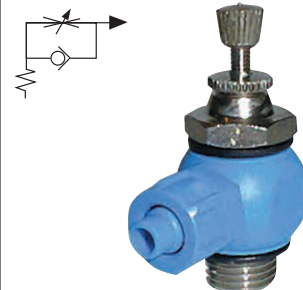

Eenrichting - uitwendige regelschroef

MRK	Symbol	Symbol	H mm	€
91040610	6 x 1/8"	14	45	9.55
91040613	6 x 1/4"	17	52	10.85
91040810	8 x 1/8"	14	45	9.55
91040813	8 x 1/4"	17	52	10.85

KELM™
pneumatiek

Hydrauliek

Snel-
koppelingen

Afsluiters

Roestvast
staal

Fittingen

Lucht-
conditionering

Gereedschap

Pneumatiek

Diversen

Malleabele
fittingen
& staal

Ringleiding-
systemen

Slangen

Compressoren

Voor

AIGNEP

opsteekkoppelingen



...zie hoofdstuk 6

Flowregelaars

Flowregelaar push-in - afvoer

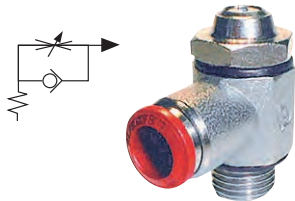

Enrichting - verzonken regelschroef

MRK				€
90090405	4 x M5	8	24	13.35
90090410	4 x 1/8"	14	31	10.75
90090610	6 x 1/8"	14	31	10.85
90090613	6 x 1/4"	17	36	11.85
90090810	8 x 1/8"	14	31	11.30
90090813	8 x 1/4"	17	36	12.15
90091013	10 x 1/4"	17	36	12.55

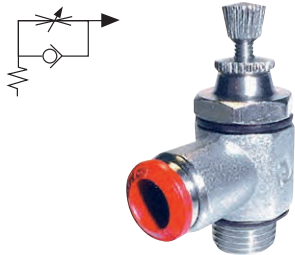

Enrichting - uitwendige regelschroef

MRK				€
91090405	4 x M5	8	35	14.75
91090410	4 x 1/8"	14	45	11.50
91090610	6 x 1/8"	14	45	11.60
91090613	6 x 1/4"	17	52	12.95
91090810	8 x 1/8"	14	45	11.95
91090813	8 x 1/4"	17	52	13.15
91091013	10 x 1/4"	17	52	13.65

Compacte flowregelaar push-in - afvoer

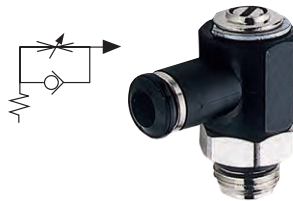

Enrichting - verzonken regelschroef - kort conisch draad met seal

MRK				€
90160405	4 x M5	8	24	15.40
90160410	4 x 1/8"	14	30.5	12.35
90160605	6 x M5	8	24	15.45
90160610	6 x 1/8"	14	30.5	12.35
90160613	6 x 1/4"	17	36	13.35
90160810	8 x 1/8"	14	30.5	12.35
90160813	8 x 1/4"	17	36	13.35

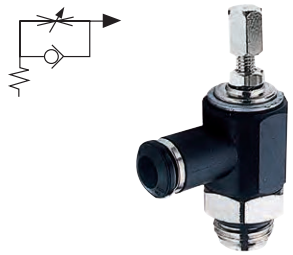

Enrichting - uitwendige regelschroef - kort conisch draad met seal

MRK				€
90170405	4 x M5	8	37.5	15.75
90170410	4 x 1/8"	14	46.5	12.55
90170605	6 x M5	8	37.5	15.75
90170610	6 x 1/8"	14	46.5	12.55
90170613	6 x 1/4"	17	53	13.65
90170810	8 x 1/8"	14	46.5	12.55
90170813	8 x 1/4"	17	53	13.65

Flowregelaar push-in - afvoer



Enrichting - uitwendige regelschroef en borgmoer

INLB		€
33310405N	4 x M5	7.45
33310413N	4 x 1/4"	8.90
33310410N	4 x 1/8"	9.05
33310605N	6 x M5	8.00
33310610N	6 x 1/8"	9.15
33310613N	6 x 1/4"	9.45
33310617N	6 x 3/8"	11.80
33310810N	8 x 1/8"	9.65
33310813N	8 x 1/4"	9.85
33310817N	8 x 3/8"	11.80
33311013N	10 x 1/4"	12.30
33311017N	10 x 3/8"	12.30
33311021N	10 x 1/2"	17.70
33311213N	12 x 1/4"	16.50
33311217N	12 x 3/8"	17.80
33311221N	12 x 1/2"	17.90

Inline flowregelaar push-in - afvoer

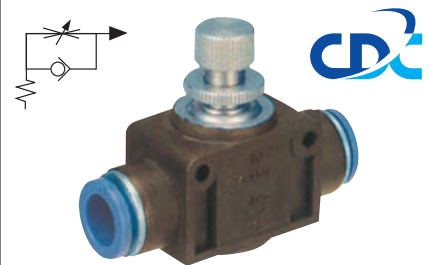

Enrichting - uitwendige regelschroef en borgmoer

INLB		€
33300400N	4	9.85
33300600N	6	11.45
33300800N	8	13.20
33301000N	10	14.70
33301200N	12	16.55

Flowregelaar BSP female - afvoer

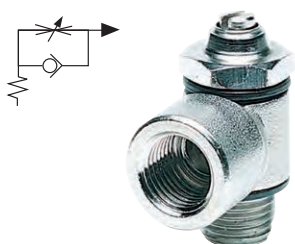

Enrichting - verzonken regelschroef

MRK				€
90111010	1/8"	14	31	9.80
90111313	1/4"	17	36	10.85

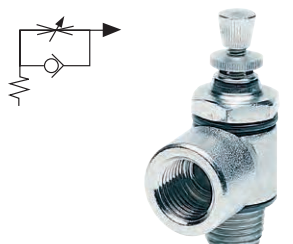

Enrichting - uitwendige regelschroef

MRK				€
91111010	1/8"	14	35	10.50
91111313	1/4"	17	45	11.95

Flowregelaars

Flowregelaar opsteek - toevoer

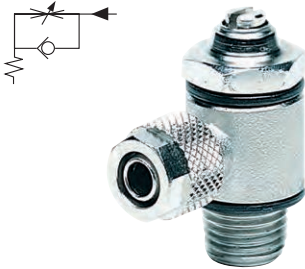

Enriching - verzonken regelschroef

MRK				€
90010405	4 x M5	8	24	12.15
90010410	4 x 1/8"	14	30.5	9.90
90010605	6 x M5	8	26	12.15
90010610	6 x 1/8"	14	31	10.15
90010613	6 x 1/4"	17	36	10.85
90010810	8 x 1/8"	14	31	10.15
90010813	8 x 1/4"	17	36	11.20
90011013	10 x 1/4"	17	36	11.30

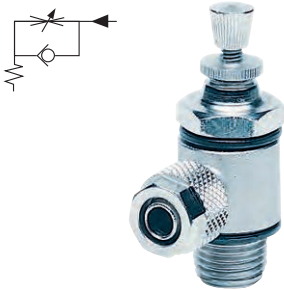

Enriching - uitwendige regelschroef

MRK				€
91010405	4 x M5	8	35	13.35
91010410	4 x 1/8"	14	45	10.75
91010605	6 x M5	8	35	13.60
91010610	6 x 1/8"	14	45	10.85
91010613	6 x 1/4"	17	52	12.25
91010810	8 x 1/8"	14	45	10.85
91010813	8 x 1/4"	17	52	12.25
91011013	10 x 1/4"	17	52	12.55

Flowregelaar opsteek (POM) - toevoer

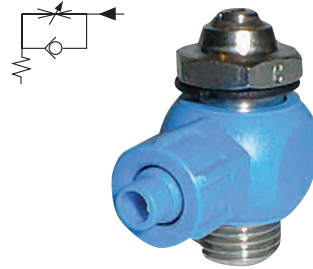

Enriching - verzonken regelschroef

MRK				€
90030610	6 x 1/8"	14	31	8.90
90030613	6 x 1/4"	17	36	9.70
90030810	8 x 1/8"	14	31	8.90
90030813	8 x 1/4"	17	36	9.70

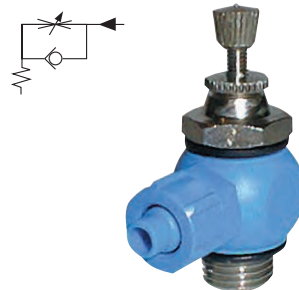

Enriching - uitwendige regelschroef

MRK				€
91030610	6 x 1/8"	14	45	9.55
91030613	6 x 1/4"	17	52	11.20
91030810	8 x 1/8"	14	45	9.55
91030813	8 x 1/4"	17	52	11.20

Flowregelaar push-in - toevoer

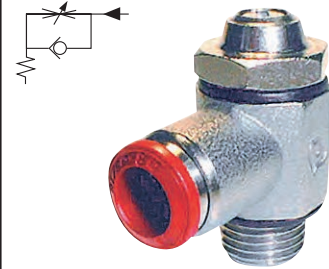

Enriching - verzonken regelschroef

MRK				€
90070405	4 x M5	8	24	13.35
90070410	4 x 1/8"	14	31	10.75
90070610	6 x 1/8"	14	31	10.85
90070613	6 x 1/4"	17	36	11.85
90070810	8 x 1/8"	14	31	11.30
90070813	8 x 1/4"	17	36	12.15
90071013	10 x 1/4"	17	36	12.55

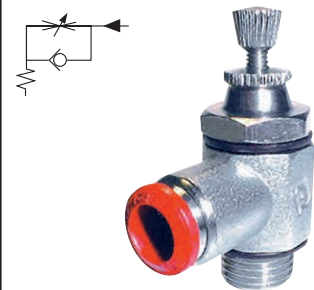

Enriching - uitwendige regelschroef

MRK				€
91070405	4 x M5	8	35	14.75
91070410	4 x 1/8"	14	45	11.50
91070610	6 x 1/8"	14	45	11.60
91070613	6 x 1/4"	17	52	13.05
91070810	8 x 1/8"	14	45	11.95
91070813	8 x 1/4"	17	52	13.35
91071013	10 x 1/4"	17	52	13.75

KELM™
pneumatiek

Hydrauliek

Snel-
koppelingen

Afsluiters

Roestvast
staal

Fittingen

Lucht-
conditionering

Gereedschap

Pneumatiek

Diversen

Malleabele
fittingen
& staal

Ringleiding-
systemen

Slangen

Compressoren

Flowregelaars

Compacte flowregelaar push-in - toevoer

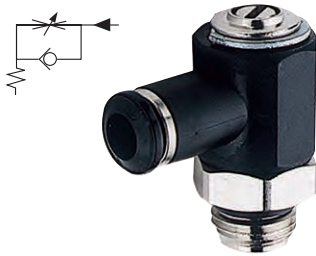

Eenrichting - verzonken regelschroef - kort conisch draad met seal

MRK				€
90180405	4 x M5	8	24	15.40
90180410	4 x 1/8"	14	30.5	12.35
90180605	6 x M5	8	24	15.40
90180610	6 x 1/8"	14	30.5	12.35
90180613	6 x 1/4"	17	36	13.35
90180810	8 x 1/8"	14	30.5	12.35
90180813	8 x 1/4"	17	36	13.25

Flowregelaar BSP female - toevoer

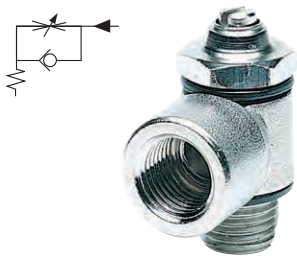

Eenrichting - verzonken regelschroef

MRK				€
90101010	1/8"	14	31	9.80
90101313	1/4"	17	36	10.85

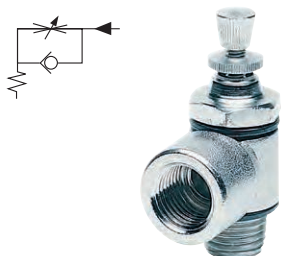

Eenrichting - uitwendige regelschroef

MRK				€
91101010	1/8"	14	35	10.50
91101313	1/4"	17	45	12.25

Flowregelaar opsteek - bidirectioneel



Tweerichting - verzonken regelschroef

MRK				€
90120405	4 x M5	8	24	9.45
90120410	4 x 1/8"	14	31	7.95
90120605	6 x M5	8	26	9.50
90120610	6 x 1/8"	14	31	8.05
90120613	6 x 1/4"	17	36	8.90
90120810	8 x 1/8"	14	31	8.10
90120813	8 x 1/4"	17	36	9.05
90121013	10 x 1/4"	17	36	9.20

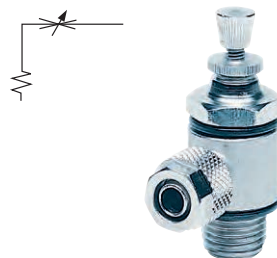

Tweerichting - uitwendige regelschroef

MRK				€
91120405	4 x M5	8	35	10.35
91120410	4 x 1/8"	14	45	9.05
91120605	6 x M5	8	43	10.35
91120610	6 x 1/8"	14	45	9.20
91120613	6 x 1/4"	17	52	9.80
91120810	8 x 1/8"	14	45	9.30
91120813	8 x 1/4"	17	52	9.90
91121013	10 x 1/4"	17	52	10.15

Flowregelaar push-in - bidirectioneel

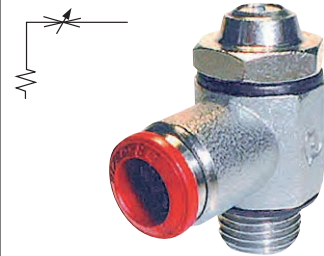

Tweerichting - verzonken regelschroef

MRK				€
90130405	4 x M5	8	24	10.75
90130410	4 x 1/8"	14	31	8.70
90130610	6 x 1/8"	14	31	8.90
90130613	6 x 1/4"	17	36	9.80
90130810	8 x 1/8"	14	31	9.20
90130813	8 x 1/4"	17	36	10.15
90131013	10 x 1/4"	17	36	10.50

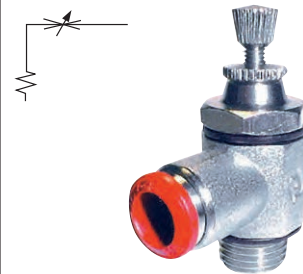

Tweerichting - uitwendige regelschroef

MRK				€
91130405	4 x M5	8	35	11.50
91130410	4 x 1/8"	14	45	9.80
91130610	6 x 1/8"	14	45	9.90
91130613	6 x 1/4"	17	52	10.75
91130810	8 x 1/8"	14	45	10.35
91130813	8 x 1/4"	17	52	11.20
91131013	10 x 1/4"	17	52	11.50

Voor

push-in koppelingen



...zie hoofdstuk 6

Flowregelaars

Flowregelaar BSP female - bidirectioneel



Tweerichting - verzonken regelschroef

MRK	BSPP		H mm	€
90141010	1/8"	14	31	7.70
90141313	1/4"	17	36	8.90



Tweerichting - uitwendige regelschroef

MRK	BSPP		H mm	€
91141010	1/8"	14	35	10.15
91141313	1/4"	17	45	11.45

Compacte flowregelaar push-in - bidirectioneel



Tweerichting - verzonken regelschroef - kort conisch draad met seal

MRK			H mm	€
90200405	4 x M5	8	24	15.40
90200410	4 x 1/8"	14	30.5	12.35
90200605	6 x M5	8	24	15.40
90200610	6 x 1/8"	14	30.5	12.35
90200613	6 x 1/4"	17	36	13.35
90200810	8 x 1/8"	14	30.5	12.35
90200813	8 x 1/4"	17	36	13.35

Inline flowregelaar BSP female

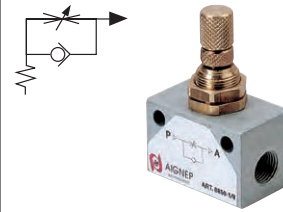

Enriching - uitwendige regelschroef

MRK			H mm	€
90050505	M5	12	26	11.35
90051010	1/8"	15	35	10.75
90051313	1/4"	15	46	14.45
90051717	3/8"	22	50	27.55
90052121	1/2"	22	60	30.00



Tweerichting - uitwendige regelschroef

MRK			H mm	€
90060505	M5	12	26	11.35
90061010	1/8"	15	35	10.75
90061313	1/4"	15	46	14.45
90061717	3/8"	22	50	27.55
90062121	1/2"	22	60	30.00

Logic ventielen

Temperatuur:
-10°C tot +60°C

Maximale werkdruk:
2 tot 10 bar

Huis: geanodiseerd aluminium
Veren: RVS
Seals: NBR
Inerne delen: messing

Medium:
Perslucht

Wisselventiel (OF-ventiel)



BSP female

6690	BSPP	ND mm	€
8870-1/8	1/8"	2.5	28.30

Tweedrukventiel (EN-ventiel)



BSP female

6690	BSPP	ND mm	€
8872-1/8	1/8"	2.5	28.85

KELM™
pneumatiek

Hydrauliek

Snel-
koppelingen

Afsluiters

Roestvast
staal

Fittingen

Lucht-
conditionering

Gereedschap

Pneumatiek

Diversen

Malleabele
fittingen &
staal

Ringleiding-
systemen

Slangen

Compressoren

Elektropneumatische ventielen



Temperatuur:
-10°C tot +60°C



Maximale werkdruk:
Monostabiel: 2 tot 10 bar
Bistabiel: 1 tot 10 bar



FLOW
1/8": 740 NI/min
1/4": 1200 NI/min



Huis: geanodiseerd aluminium
Spoel: chemisch vernikkeld
Seals: NBR

Elektropneumatische ventielen worden standaard geleverd zonder spoel en stekker. Deze zijn te vinden op pagina 637

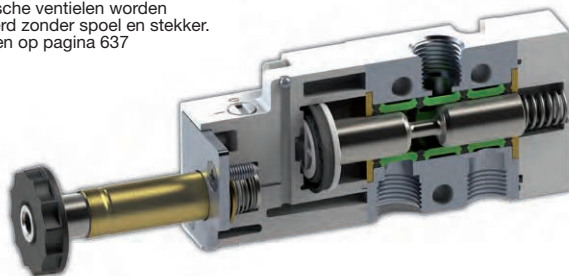

Elektropneumatische 3/2 ventielen

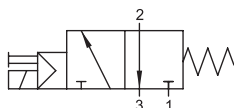

NC - monostabiel veerretour

6690	BSPP	€
01VS03NC02	1/8"	79.00
01VS03NC03	1/4"	85.90

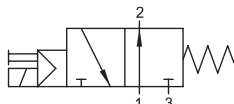

NO - monostabiel veerretour

6690	BSPP	€
01VS03NO02	1/8"	79.00
01VS03NO03	1/4"	85.90

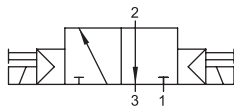

Bistabiel

6690	BSPP	€
01VS130002	1/8"	105.05
01VS130003	1/4"	112.20

Elektropneumatische 5/2 ventielen

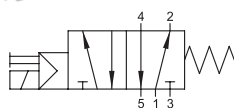

Monostabiel veerretour

6690	BSPP	€
01VS050002	1/8"	85.10
01VS050003	1/4"	91.15

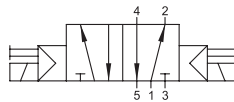

Bistabiel

6690	BSPP	€
01VS150002	1/8"	109.15
01VS150003	1/4"	120.00

Elektropneumatische 5/3 ventielen

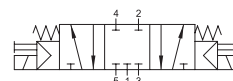

Monostabiel veerretour - CC
middenstand gesloten

6690	BSPP	€
01VS07CC02	1/8"	139.60
01VS07CC03	1/4"	157.85

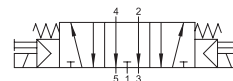

Monostabiel veerretour - OC
middenstand geopend

6690	BSPP	€
01VS07OC02	1/8"	139.60
01VS07OC03	1/4"	157.85

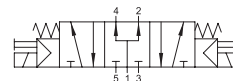

Monostabiel veerretour - PC
middenstand onder druk

6690	BSPP	€
01VS07PC02	1/8"	139.60
01VS07PC03	1/4"	157.85

Luchtbediende ventielen



Temperatuur:
-10°C tot +60°C



Maximale werkdruk:
Monostabiel: 2 tot 10 bar
Bistabiel: 1 tot 10 bar



FLOW
1/8": 740 NI/min
1/4": 1200 NI/min



Huis: geanodiseerd aluminium
Spoel: chemisch vernikkeld
Seals: NBR

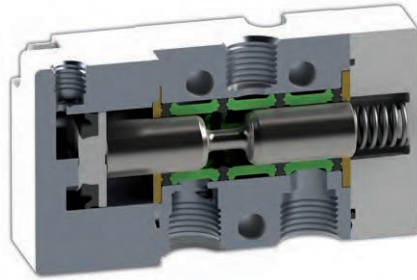

Luchtbediende 3/2 ventielen

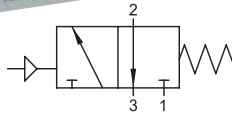

NC - monostabiel veerretour

6690	BSPP	€
01VP03NC02	1/8"	59.60
01VP03NC03	1/4"	62.15

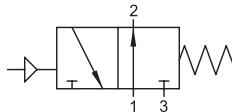

NO - monostabiel veerretour

6690	BSPP	€
01VP03NO02	1/8"	59.60
01VP03NO03	1/4"	62.15

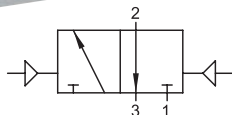

Bistabiel

6690	BSPP	€
01VP130002	1/8"	67.95
01VP130003	1/4"	70.75

Luchtbediende 5/2 ventielen

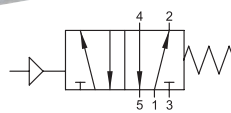

Monostabiel veerretour

6690	BSPP	€
01VP050002	1/8"	66.40
01VP050003	1/4"	71.15

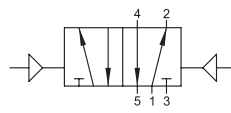

Bistabiel

6690	BSPP	€
01VP150002	1/8"	77.55
01VP150003	1/4"	80.60

Luchtbediende 5/3 ventielen

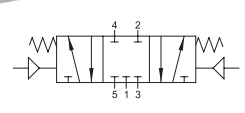

Monostabiel veerretour - CC
middenstand gesloten

6690	BSPP	€
01VP07CC02	1/8"	79.70
01VP07CC03	1/4"	82.45

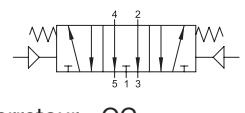

Monostabiel veerretour - OC
middenstand geopend

6690	BSPP	€
01VP07OC02	1/8"	79.70
01VP07OC03	1/4"	82.45

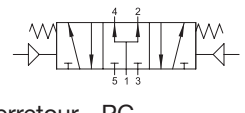

Monostabiel veerretour - PC
middenstand onder druk

6690	BSPP	€
01VP07PC02	1/8"	79.70
01VP07PC03	1/4"	82.45

KELM™
pneumatiek

Hydrauliek

Snel-
koppelingen

Afsluiters

Roestvast
staal

Fittingen

Lucht-
conditionering

Gereedschap

Pneumatiek

Diversen

Malleabele
fittingen &
staal

Ringleiding-
systemen

Slangen

Compressoren

Handbediende ventielen

- Temperatuur:**
-10°C tot +60°C
- Maximale werkdruk:**
0 tot 10 bar
- FLOW**
1/8": 740 NI/min
1/4": 1200 NI/min
- Huis:** geanodiseerd aluminium
Spoel: chemisch vernikkeld
Seals: NBR

Paneelmontage:
M16x1

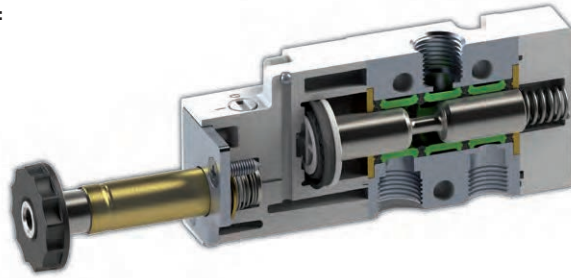

Handbediende 3/2 ventielen - trek/drukknop

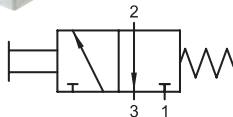

NC - monostabiel veerretour

6690		€
01VT03NC02	1/8"	62.45
01VT03NC03	1/4"	67.95

Handbediende 5/2 ventielen - trek/drukknop

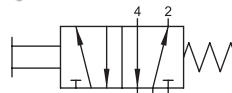

Monostabiel veerretour

6690		€
01VT050002	1/8"	72.80
01VT050003	1/4"	79.60

Handbediende 3/2 ventielen - 90° hefboom

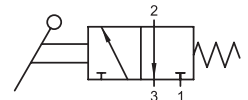

NC - monostabiel veerretour

6690		€
01VL03NC02	1/8"	73.20
01VL03NC03	1/4"	77.80

Bistabiel

6690		€
01VT130002	1/8"	62.45
01VT130003	1/4"	67.95

Bistabiel

6690		€
01VT150002	1/8"	72.80
01VT150003	1/4"	79.60

Bistabiel

6690		€
01VL130002	1/8"	76.30
01VL130003	1/4"	82.05

Handbediende ventielen

Handbediende 5/2 ventielen - 90° hefboom

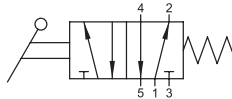

Monostabiel veerretour

6690	BSPP	€
01VL050002	1/8"	83.35
01VL050003	1/4"	90.00

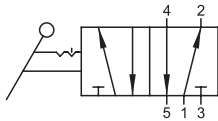

Bistabiel

6690	BSPP	€
01VL150002	1/8"	86.10
01VL150003	1/4"	93.95

Handbediende 5/3 ventielen - 90° hefboom

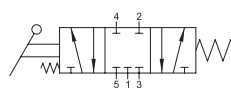

Monostabiel veerretour - CC middenstand gesloten

6690	BSPP	€
01VL07CC02	1/8"	92.65
01VL07CC03	1/4"	100.80

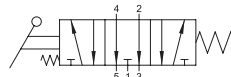

Monostabiel veerretour - OC middenstand geopend

6690	BSPP	€
01VL07OC02	1/8"	92.65
01VL07OC03	1/4"	100.80



Monostabiel veerretour - PC middenstand onder druk

6690	BSPP	€
01VL07PC02	1/8"	92.65
01VL07PC03	1/4"	100.80

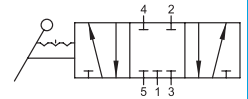

Bistabiel - CC middenstand gesloten

6690	BSPP	€
01VL27CC02	1/8"	92.65
01VL27CC03	1/4"	100.80

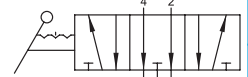

Bistabiel - OC middenstand geopend

6690	BSPP	€
01VL27OC02	1/8"	92.65
01VL27OC03	1/4"	100.80



Bistabiel - PC middenstand onder druk

6690	BSPP	€
01VL27PC02	1/8"	92.65
01VL27PC03	1/4"	100.80

KELM™
pneumatiek

Hydrauliek

Snel-
koppelingen

Afsluiters

Roestvast
staal

Fittingen

Lucht-
conditionering

Gereedschap

Pneumatiek

Diversen

Malleabele
fittingen
& staal

Ringleiding-
systemen

Slangen

Compressoren

Basisplaten

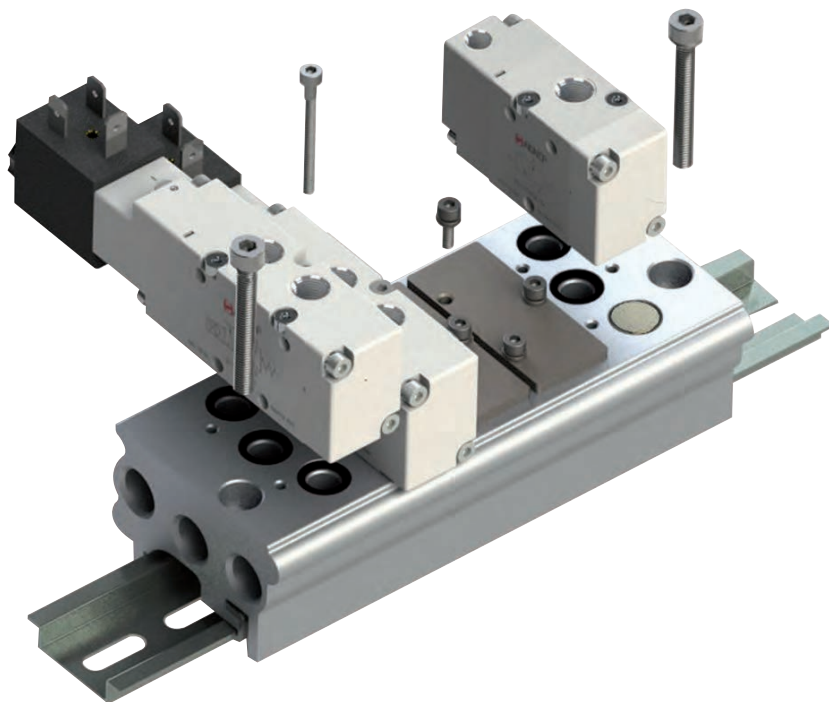

1/8" - compleet met schroeven en O-ring

6690	BSPP	No. of Stations	€
01VB000002	1/8"	2	53.25
01VB000003	1/8"	3	62.00
01VB000004	1/8"	4	70.05
01VB000005	1/8"	5	77.65
01VB000006	1/8"	6	84.35
01VB000007	1/8"	7	92.20
01VB000008	1/8"	8	99.95
01VB000009	1/8"	9	109.35
01VB000010	1/8"	10	120.70

1/4" - compleet met schroeven en O-ring

6690	BSPP	No. of Stations	€
01VB010002	1/4"	2	54.25
01VB010003	1/4"	3	63.35
01VB010004	1/4"	4	72.80
01VB010005	1/4"	5	80.40
01VB010006	1/4"	6	88.05
01VB010007	1/4"	7	96.15
01VB010008	1/4"	8	104.70
01VB010009	1/4"	9	114.10
01VB010010	1/4"	10	124.05

Accessoires basisplaten



Pluggen voor drieweg ventilaansluiting

6690	BSPP	€
01VB600000	1/8"	1.75
01VB600001	1/4"	1.95



Pluggen voor basisplaat

6690	BSPP	€
01VB800000	1/8"	1.75
01VB800001	1/4"	1.95



Blindplaten

6690	BSPP	€
01VB900000	1/8"	3.40
01VB900001	1/4"	3.75

Magneetventielen



Temperatuur:
-10°C tot +60°C



Maximale werkdruk:
0 tot 10 bar



300 NI/min



Huis: geanodiseerd aluminium
Seals: NBR

Magneetventielen worden standaard geleverd zonder spoel en stekker.



Magneetventielen 3/2

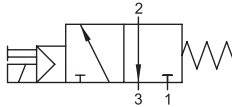

NC - met manual override



07VS03NC02	1/8"	40.80
07VS03NCX1	4mm	47.65

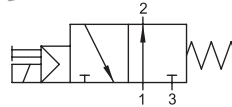

NO - met manual override



07VS03NO02	1/8"	40.80
07VS03NOX1	4mm	47.65

Spoelen en stekkers

Voltage tolerantie: ±10%
Isolatieklasse: F CEI EN 60085
IP65 IEC 60529 met stekker



Spoelen - DIN 43650 B



SOL01012C1000	12V DC 3W	12.10
SOL01024A2000	24V AC 5VA	12.10
SOL01024C1000	24V DC 3W	12.10
SOL01024C3000	24V DC 2W	12.10
SOL01110A2000	110V AC 5VA	12.10
SOL01220A2000	220V AC 5VA	12.10

Isolatieklasse: IP65 IEC 60529 met stekker
Kabeldiameter: 6-8mm



Stekkers - standaard



CON0100001 standaard A 2 pins Zwart 2.75

Isolatieklasse: IP65 IEC 60529 met stekker
Kabeldiameter: 6-8mm



Stekkers - LED



CON0202400	LED+VDR 0-24V	Transparant	11.70
CON0211000	LED+VDR 110V	Transparant	11.70
CON0225000	LED+VDR 220V	Transparant	11.70

KELM™
pneumatiek

Hydrauliek

Snel-
koppelingen

Afsluiters

Roestvast
staal

Fittingen

Lucht-
conditionering

Gereedschap

Pneumatiek

Diversen

Malleabele
fittingen
& staal

Ringleiding-
systemen

Slangen

Compressoren

Handbediende ventielen



Tech Data 20292

FLOW
 Serie 100: 75 l/min bij 6 bar /ΔP 1
 Serie 120: 490 l/min bij 6 bar /ΔP 1
 Serie 125: 800 l/min bij 6 bar /ΔP 1
 Serie 140: 8mm: 75 l/min bij 6 bar /ΔP 1
 Serie 140: 1/4" 550 l/min bij 6 bar /ΔP 1

mat Huis Kunststof (technopolymeer)
 Delen, messing en RVS
SEAL NBR

Serie 120 Ventielen met technopolymeer huis.
 Geschikt voor single use.
 Serie 125 Ventielen met technopolymeer huis.
 Geschikt voor single use & battery assembly.

Van alle Aircomp producten zijn op aanvraag technische tekeningen met inbouwmaten beschikbaar.

Serie 120 - 1/8"

Temperatuur:
 -5°C tot 50°C
 Voetbediend pneumatisch -10°C tot 50°C
 Voetbediend elektrisch -25°C tot 70°C

Medium:
 Gesmeerde of ongesmeerde
 geconditioneerde perslucht

Maximale werkdruk:
 0 - 10 bar



Hoofdstuk 9 - Pneumatiek

3/2 handbediend ventiel - 1/8" BSP female

VEN		Funcie	Lucht	€
2038-6470	AC HB 3/2 1/8" NC DK Handbediend met Drukknop, Veerretour		1/8"	31.90
2038-6488	AC HB 3/2 1/8" DK Handbediend met Trek/Drukknop		1/8"	31.90
2038-6496	AC HB 3/2 1/8" NC TUI Handbediend met Tuimelaar, Veerretour		1/8"	38.25
2038-6504	AC HB 3/2 1/8" TUI Handbediend met Tuimelaar		1/8"	34.55
2038-6512	AC HB 3/2 1/8" NC ZTUI Handbediend met Zij-Tuimelaar, Veerretour		1/8"	39.80
2038-6520	AC HB 3/2 1/8" ZTUI Handbediend met Zij-Tuimelaar		1/8"	39.65

5/2 handbediend ventiel - zij uitvoering - 1/8" BSP female

VEN		Funcie	Lucht	€
2038-6678	AC HB 5/2 1/8" ZTUI Veerr Handbediend met Zij-Tuimelaar, Veerretour		1/8"	43.65
2038-6686	AC HB 5/2 1/8" TUI Handbediend met Zij-Tuimelaar		1/8"	43.65

5/3 handbediend ventiel - zij uitvoering - 1/8" BSP female

VEN		Funcie	Lucht	€
2038-6694	AC HB 5/3 1/8" ZTUI Mid Gesl Handbediend met Zij-Tuimelaar		1/8"	45.70
2038-6702	AC HB 5/3 1/8" ZTUI Mid Geop Handbediend met Zij-Tuimelaar		1/8"	45.70
2038-6710	AC HB 5/3 1/8" ZTUI Mid Druk Handbediend met Zij-Tuimelaar		1/8"	45.70
2038-6728	AC HB 5/3 1/8" ZTUI Mid Gesl RTC Handbediend met Zij-Tuimelaar, Return To Centre		1/8"	48.95
2038-6736	AC HB 5/3 1/8" ZTUI Mid Geop RTC Handbediend met Zij-Tuimelaar, Return To Centre		1/8"	48.95
2038-6744	AC HB 5/3 1/8" ZTUI Mid Druk RTC Handbediend met Zij-Tuimelaar, Return To Centre		1/8"	48.95

5/2 handbediend ventiel - 1/8" BSP female

VEN		Funcie	Lucht	€
2038-6538	AC HB 5/2 1/8" DK Veerr Handbediend met Drukknop, Veerretour		1/8"	35.55
2038-6546	AC HB 5/2 1/8" DK Handbediend met Trek/Drukknop		1/8"	35.55
2038-6595	AC HB 5/2 1/8" TUI Veerr Handbediend met Tuimelaar, Veerretour		1/8"	39.25
2038-6603	AC HB 5/2 1/8" TUI Handbediend met Tuimelaar		1/8"	38.15

5/3 handbediend ventiel - 1/8" BSP female

VEN		Funcie	Lucht	€
2038-6553	AC HB 5/3 1/8" DK Mid Gesloten RTC Handbediend met Drukknop, Return To Centre		1/8"	45.70
2038-6561	AC HB 5/3 1/8" DK Mid Geopend RTC Handbediend met Drukknop, Return To Centre		1/8"	45.70
2038-6587	AC HB 5/3 1/8" DK Mid Druk RTC Handbediend met Drukknop, Return To Centre		1/8"	45.70
2038-6611	AC HB 5/3 1/8" TUI Mid Gesloten Handbediend met Tuimelaar		1/8"	57.15
2038-6629	AC HB 5/3 1/8" TUI Mid Geopend Handbediend met Tuimelaar		1/8"	57.15
2038-6637	AC HB 5/3 1/8" TUI Mid Druk Handbediend met Tuimelaar		1/8"	57.15
2038-6645	AC HB 5/3 1/8" TUI Mid Gesl RTC Handbediend met Tuimelaar, Return To Centre		1/8"	56.70
2038-6652	AC HB 5/3 1/8" TUI Mid Geop RTC Handbediend met Tuimelaar, Return To Centre		1/8"	56.70
2038-6660	AC HB 5/3 1/8" TUI Mid Druk RTC Handbediend met Tuimelaar, Return To Centre		1/8"	56.70

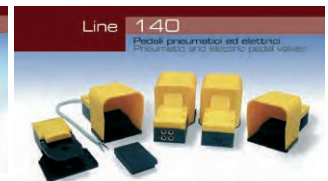

Handbediende ventielen

Serie 125 - 1/4"

 **Maximale werkdruk:**
0 - 10 bar



Zij-Tuimelaar



Trek/Druk













Tuimelaar

5/2 handbediend ventiel - 1/4" BSP female

VEN		Funcie	Lucht	€
1252335001		AC HB 5/2 1/4" DK Veerr Handbediend met Drukknop, Veerretour	 1/4"	39.25
1252335002		AC HB 5/2 1/4" DK Handbediend met Trek/Drukknop	 1/4"	39.25
1252335003		AC HB 5/2 1/4" TUI Veerretour Handbediend met Tuimelaar, Veerretour	 1/4"	43.25
1252335004		AC HB 5/2 1/4" TUI Handbediend met Tuimelaar	 1/4"	41.90







5/3 handbediend ventiel - 1/4" BSP female

VEN		Funcie	Lucht	€
1252336013		AC HB 5/3 1/4" DK Mid Gesl RTC Handbediend met Drukknop, Return To Centre	 1/4"	50.35
1252336014		AC HB 5/3 1/4" DK Mid Geop RTC Handbediend met Drukknop, Return To Centre	 1/4"	50.35
1252336015		AC HB 5/3 1/4" DK Mid Druk RTC Handbediend met Drukknop, Return To Centre	 1/4"	50.35
1252336001		AC HB 5/3 1/4" TUI Mid Gesl Handbediend met Tuimelaar	 1/4"	56.10
1252336002		AC HB 5/3 1/4" TUI Mid Geop Handbediend met Tuimelaar	 1/4"	56.10
1252336003		AC HB 5/3 1/4" TUI Mid Druk Handbediend met Tuimelaar	 1/4"	56.10
1252336004		AC HB 5/3 1/4" TUI Mid Gesl RTC Handbediend met Tuimelaar, Return To Centre	 1/4"	59.20
1252336005		AC HB 5/3 1/4" TUI Mid Geop RTC Handbediend met Tuimelaar, Return To Centre	 1/4"	59.20
1252336006		AC HB 5/3 1/4" TUI Mid Druk RTC Handbediend met Tuimelaar, Return To Centre	 1/4"	59.20

5/2 handbediend ventiel - zij uitvoering - 1/4" BSP female

VEN		Funcie	Lucht	€
1252335005		AC HB 5/2 1/4" ZTUI Veerr Handbediend met Zij-Tuimelaar, Veerretour	 1/4"	48.00
1252335006		AC HB 5/2 1/4" ZTUI Handbediend met Zij-Tuimelaar	 1/4"	48.00

5/3 handbediend ventiel - zij uitvoering - 1/4" BSP female

VEN		Funcie	Lucht	€
1252336007		AC HB 5/3 1/4" ZTUI Mid Gesl Handbediend met Zij-Tuimelaar	 1/4"	50.35
1252336008		AC HB 5/3 1/4" ZTUI Mid Geop Handbediend met Zij-Tuimelaar	 1/4"	50.35
1252336009		AC HB 5/3 1/4" ZTUI mid druk Handbediend met Zij-Tuimelaar	 1/4"	50.35
1252336010		AC HB 5/3 1/4" ZTUI Mid Gesl RTC Handbediend met Zij-Tuimelaar, Return to Centre	 1/4"	54.05
1252336011		AC HB 5/3 1/4" ZTUI Mid Geop RTC Handbediend met Zij-Tuimelaar, Return to Centre	 1/4"	54.05
1252336012		AC HB 5/3 1/4" ZTUI Mid Druk RTC Handbediend met Zij-Tuimelaar, Return to Centre	 1/4"	54.05

Voor
basisplaten
serie 125



...zie pagina 647

KELM™
pneumatiek

Hydrauliek

Snel-
koppelingen

Afsluiters

Roestvast
staal

Fittingen

Lucht-
conditionering

Gereedschap

Pneumatiek

Diversen

Malleabele
fittingen &
staal

Ringleiding-
systemen

Slangen

Compressoren

Handbediende ventielen



Serie 120 - 1/8"



Maximale werkdruk:
0 - 10 bar

Let op: deze ventielen worden geleverd zonder schakelaar.



3/2 handbediend ventiel - exclusief schakelaar - 1/8" BSP female



2038-6942	AC HB 3/2 1/8" NC ZS Handbediend, NC, Zonder Schakelaar		1/8"	35.95
2038-6959	AC HB 3/2 1/8" NO ZS Handbediend, NO, Zonder Schakelaar		1/8"	35.95

5/2 handbediend ventiel - exclusief schakelaar - 1/8" BSP female



2038-7064	AC HB 5/2 1/8" ZS Handbediend, Zonder Schakelaar		1/8"	39.80
------------------	--	--	------	--------------

Serie 125 - 1/4"



Maximale werkdruk:
1 - 10 bar



5/2 handbediend ventiel - exclusief schakelaar - 1/4" BSP female



1252535005	AC HB 5/2 1/4" ZS Handbediend, Zonder Schakelaar		1/4"	43.65
-------------------	--	--	------	--------------

Schakelaars

Schakelaars met metalen behuizing voor handbediende ventielen zonder schakelaar van serie 100, 120 en 125.



Sleutelschakelaar



2038-7296	AC SSSCHA-M 2S Sleutel Sleutelschakelaar, 2 Standen			40.85
------------------	---	--	--	--------------

Draaischakelaar



2038-7304	AC SCHA-M 2S Draai 29,5 Draaischakelaar, 2 Standen, Handel 29,5mm			25.00
2038-7312	AC SCHA-M 2S draai 29,5, VR Draaischakelaar, 2 Standen, Veerretour, Handel 29,5mm			25.00
2038-7320	AC SCHA-M 3S Draai 29,5 Draaischakelaar, 3 Standen, Handel 29,5mm			25.00
2038-7338	AC SCHA-M 3S Draai 29,5, RTC Draaischakelaar, 3 Standen, Return to Centre, Handel 29,5mm			25.00
2038-7346	AC SCHA-M 2S Draai 39 Draaischakelaar, 2 Standen, Handel 39mm			25.85
2038-7361	AC SCHA-M 2S Draai 39, VR Draaischakelaar, 2 Standen, Veerretour, Handel 39mm			25.85
2038-7379	AC SCHA-M 3S Draai 39 Draaischakelaar, 3 Standen, Handel 39mm			25.85
2038-7387	AC SCHA-M 3S Draai 39, RTC Draaischakelaar, 3 Standen, Return to Centre, Handel 39mm			25.85

Knopkap (t.b.v. drukknopschakelaar)



1003A00048	AC Knopkap, Zwart T.b.v. Drukknopschakelaar		5.25
1003A00049	AC Knopkap, Rood T.b.v. Drukknopschakelaar		3.75
2038-7429	AC Knopkap, Blauw T.b.v. Drukknopschakelaar		4.90
2038-7437	AC Knopkap, Geel T.b.v. Drukknopschakelaar		4.90
2038-7445	AC Knopkap, Groen T.b.v. Drukknopschakelaar		4.90

Paddestoelschakelaar



2038-7510	AC BI 40mm Paddestoel, Rood Bidirectionele Paddestoelschakelaar		20.25
2038-7528	AC BI 40mm Paddestoel Zwart Bidirectionele Paddestoelschakelaar		19.85
2038-7585	AC DR 40mm Paddestoel, Rood Om as Draaiende Paddestoelschakelaar		32.40
2038-7593	AC DR 60mm Paddestoel, Rood Om as Draaiende Paddestoelschakelaar		37.60

Drukknopschakelaar (zonder knopkap)



2038-7403	AC M Drukknop (zonder knopkap)			13.65
------------------	--------------------------------	--	--	--------------

Pookschakelaar



2038-7577	AC MU Pook, Rood Multidirectionele Pookschakelaar			29.05
------------------	---	--	--	--------------

Mechanisch bediende ventielen

Serie 120 - 1/8"



Maximale werkdruk:
Zonder hulplucht 0 - 10 bar
Met hulplucht 1 - 10 bar

Tech Data
20292

1 Richting



3/2 mechanisch bediend ventiel - 1/8" BSP female

VEN		Functie	Lucht	€
2038-6751	AC MB 3/2 1/8" NC SB Mechanisch, Stiftbediend		1/8"	27.45
2038-6769	AC MB 3/2 1/8" NO SB Mechanisch, Stiftbediend		1/8"	27.45
2038-6777	AC MB 3/2 1/8" NC SB-HL Mechanisch, Stiftbediend, Hulplucht		1/8"	34.90
2038-6785	AC MB 3/2 1/8" NO SB-HL Mechanisch, Stiftbediend, Hulplucht		1/8"	34.90
2038-6793	AC MB120 3/2 1/8" NC SB-HL Pan Mechanisch, Stiftbediend, Hulplucht, Paneelmontage		1/8"	37.20
2038-6819	AC MB 3/2 1/8" NO SB-HL Pan Mechanisch, Stiftbediend, Hulplucht, Paneelmontage		1/8"	37.20
2038-6827	AC MB 3/2 1/8" NC VRA Mechanisch, Verlengde Rolarm Bediend		1/8"	36.70
2038-6835	AC MB 3/2 1/8" NO VRA Mechanisch, Verlengde Rolarm Bediend		1/8"	36.70
2038-6868	AC MB 3/2 1/8" NC RA-HL Mechanisch, Rolarm Bediend, Hulplucht		1/8"	41.55
2038-6876	AC MB 3/2 1/8" NO RA-HL Mechanisch, Rolarm Bediend, Hulplucht		1/8"	41.55
2038-6843	AC MB 3/2 1/8" NC RA1 Mechanisch, Rolarm Bediend, 1 Richting		1/8"	39.55
2038-6850	AC MB 3/2 1/8" NO RA1 Mechanisch, Rolarm Bediend, 1 Richting		1/8"	39.55
2038-6884	AC MB 3/2 1/8" NC RA1-HL, Mechanisch, Rolarm Bediend, 1 Richting, Hulplucht		1/8"	43.95
2038-6892	AC MB 3/2 1/8" NO RA1-HL, Mechanisch, Rolarm Bediend, 1 Richting, Hulplucht		1/8"	43.95
2038-6900	AC MB 3/2 1/8" NC HEF-HL Mechanisch, Hefboom Bediend, Hulplucht		1/8"	38.75
2038-6918	AC MB 3/2 1/8" NO HEF-HL Mechanisch, Hefboom Bediend, Hulplucht		1/8"	38.75
2038-6926	AC MB 3/2 1/8" NC ANT Mechanisch, Antenne Bediend		1/8"	40.55
2038-6934	AC MB 3/2 1/8" NO ANT Mechanisch, Antenne Bediend		1/8"	40.55

5/2 mechanisch bediend ventiel - 1/8" BSP female

VEN		Functie	Lucht	€
2038-6975	AC MB 5/2 1/8" SB Veerr Mechanisch, Stiftbediend		1/8"	31.55
2038-6983	AC MB 5/2 1/8" SB-HL Veerr Mechanisch, Stiftbediend, Hulplucht		1/8"	38.75
2038-6991	AC MB 5/2 1/8" SB-HL Pan Veerr Mechanisch, Stiftbediend, Hulplucht, Paneelmontage		1/8"	46.15
2038-7007	AC MB 5/2 1/8" RA Veerr Mechanisch, Verlengde Rolarm Bediend		1/8"	41.35
2038-7023	AC MB 5/2 1/8" RA-HL Veerr Mechanisch, Rolarm Bediend, Hulplucht		1/8"	46.05
2038-7015	AC MB 5/2 1/8" RA1 Veerr Mechanisch, Rolarm Bediend, 1 Richting		1/8"	44.30
2038-7031	AC MB 5/2 1/8" RA1-HL Veerr Mechanisch, Rolarm Bediend, 1 Richting, Hulplucht		1/8"	48.60
2038-7049	AC MB 5/2 1/8" HEF-HL Veerr Mechanisch, Hefboom Bediend, Hulplucht		1/8"	42.55
2038-7056	AC MB120 5/2 1/8" ANT-HL Veerr Mechanisch, Antenne Bediend, Hulplucht		1/8"	44.10

Serie 125 - 1/4"



Maximale werkdruk:
Zonder hulplucht 0 - 10 bar
Met hulplucht 1 - 10 bar

Tech Data
20292

1 Richting



5/2 mechanisch bediend ventiel - 1/4" BSP female

VEN		Functie	Lucht	€
1252435001	AC MB 5/2 1/4" SB Veerr Mechanisch, Stiftbediend		1/4"	34.65
1252535001	AC MB 5/2 1/4" SB-HL Veerr Mechanisch, Stiftbediend, Hulplucht		1/4"	42.65
1252535004	AC MB 5/2 1/4" SB-HL Pan Veerr Mechanisch, Stiftbediend, Hulplucht, Paneelmontage		1/4"	48.10
1252435002	AC MB 5/2 1/4" RA Veerr Mechanisch, Rolarm Bediend		1/4"	42.20
1252535002	AC MB 5/2 1/4" RA-HL Veerr Mechanisch, Rolarm Bediend, Hulplucht		1/4"	50.50
1252435003	AC MB 5/2 1/4" RA1 Veerr Mechanisch, Rolarm Bediend, 1 Richting		1/4"	44.45
1252535003	AC MB 5/2 1/4" RA1-HL Veerr Mechanisch, Rolarm Bediend, 1 Richting, Hulplucht		1/4"	53.35
1252435006	AC MB 5/2 1/4" BA Veerr Mechanisch, Balarm Bediend		1/4"	44.10
1252435007	AC MB 5/2 1/4" BA1 Veerr Mechanisch, Balarm Bediend, 1 Richting		1/4"	46.35
1252535006	AC MB 5/2 1/4" HEF-HL Veerr Mechanisch, Hefboom Bediend, Hulplucht		1/4"	46.65
1252535007	AC MB 5/2 1/4" ANT Veerr Mechanisch, Antenne Bediend		1/4"	43.40

KELM™ pneumatiek
Hydrauliek
Snelkoppelingen
Afsluiters
Roestvast staal
Fittingen
Luchtconditionering
Gereedschap
Pneumatiek
Diversen
Malleabele fittingen & staal
Ringleidingssystemen
Slangen
Compressoren

Tech Data 10465

Temperatuur:
-10°C t/m 50°C

Maximale werkdruk:
2 - 10 bar

Serie 140 - 4mm push-in

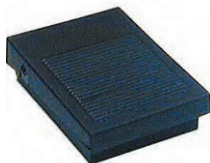

3/2 voetbediend micro ventiel - monostabiel - zonder beschermkap - 4mm push-in

VEN		Functie		€
PED304M	AC Micro VB 3/2 4mm MS Voetbediend, Monostabiel		4mm Push-in	48.20



3/2 voetbediend ventiel - monostabiel - 4mm push-in

VEN		Functie		€
1407493001	AC VB 3/2 4mm BK MS Voetbediend, Beschermkap, Monostabiel		4mm Push-in	48.85

3/2 voetbediend ventiel - bistabiel - 4mm push-in

VEN		Functie		€
1407493003	AC VB 3/2 4mm BK BS Voetbediend, Beschermkap, Bistabiel		4mm Push-in	52.00

Serie 140 - 1/4"



5/2 voetbediend ventiel - monostabiel - zonder beschermkap - 1/4" BSP female

VEN		Functie	Lucht	€
PED502M	AC VB 5/2 1/4" MS Voetbediend, Monostabiel		1/4"	64.25

5/2 voetbediend ventiel - bistabiel - zonder beschermkap - 1/4" BSP female

VEN		Functie	Lucht	€
1407535005	AC VB 5/2 1/4" BS Voetbediend, Bistabiel		1/4"	68.05



5/2 voetbediend ventiel - monostabiel - 1/4" BSP female

VEN		Functie	Lucht	€
PED502S	AC VB 5/2 1/4" BK MS Voetbediend, Beschermkap, Monostabiel		1/4"	71.90

5/2 voetbediend ventiel - bistabiel - 1/4" BSP female

VEN		Functie	Lucht	€
PED502B	AC VB 5/2 1/4" BK BS Voetbediend, Beschermkap, Bistabiel		1/4"	75.95

Serie 140 - elektrische schakelaar 24/230V

Temperatuur:
-25°C t/m 70°C



Verschillende uitvoeringen zijn leverbaar met safety device.

Voetbediend ventiel - elektrische schakelaar 24/230V - monostabiel - levering met kabel

VEN		€
1407660801	AC VB Elektr Schak BK MS Voetbediend, Beschermkap, Monostabiel	47.40

Voor



terugslagkleppen



...zie hoofdstuk 4

Luchtbediende ventielen



Medium:

Gesmeerde of ongesmeerde geconditioneerde perslucht



Temperatuur: -5°C tot 50°C



FLOW Serie 120: 490 L/min bij 6 bar /ΔP 1
Serie 125: 800 L/min bij 6 bar /ΔP 1



Huis Kunststof (technopolymeer)
Delen, messing en RVS



NBR

Serie 120 - 1/8"



Maximale werkdruk:

Werkdruk: 0 - 10 bar
Stuurdruk: Monostabiel: 1 - 10. bar
Bistabiel: 0,5 - 10 bar

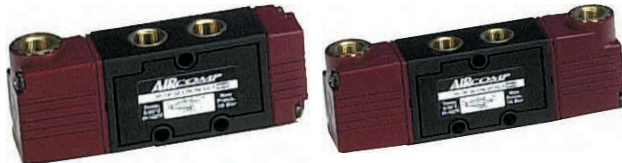

3/2 luchtbediend ventiel - 1/8" BSP female

VEN		Functie	Lucht	€
2038-6371	AC LB 3/2 1/8" HL NC Lucht - Veer, Hulplucht		1/8"	28.25
2038-6389	AC LB 3/2 1/8" HL NO Lucht - Veer, Hulplucht		1/8"	28.25
2038-6397	AC LB 3/2 1/8" Bistabiel Lucht - Lucht		1/8"	32.95
2038-6405	AC LB 3/2 1/8" Differentieel Lucht - Lucht, Luchtretour		1/8"	34.00

5/2 luchtbediend ventiel - 1/8" BSP female

VEN		Functie	Lucht	€
2038-6413	AC LB 5/2 1/8" HL Veerretour Lucht - Veer, Hulplucht		1/8"	31.65
2038-6421	AC LB 5/2 1/8" Bistabiel Lucht - Lucht		1/8"	34.55
2038-6439	AC LB 5/2 1/8" Differentieel Lucht - Lucht, Luchtretour		1/8"	38.40

5/3 luchtbediend ventiel - 1/8" BSP female

VEN		Functie	Lucht	€
2038-6447	AC LB 5/3 1/8" Midden Gesloten RTC Lucht - Lucht, Return to Centre		1/8"	52.70
2038-6454	AC LB 5/3 1/8" Midden Geopend RTC Lucht - Lucht, Return to Centre		1/8"	52.70
2038-6462	AC LB 5/3 1/8" Midden Druk RTC Lucht - Lucht, Return to Centre		1/8"	52.70

Serie 125 - 8mm push-in



Maximale werkdruk:

Werkdruk: 0 - 10 bar
Stuurdruk: 5/2 Monostabiel: 1 - 10. 5/2 bar
Bistabiel/differentieel: 0,5 - 10. 5/3 bar
Bistabiel: 2,1 - 10 bar



5/2 luchtbediend ventiel - 8mm push-in

VEN		Functie	Lucht	€
1252295001	Ac Lb 5/2 8mm Veerr Lucht - Veer, Hulplucht		8mm Push-in	34.25
1252295002	Ac Lb 5/2 8mm Bistabiel Lucht - Lucht		8mm Push-in	37.10
1252295003	Ac Lb 5/2 8mm Differentieel Lucht - Lucht, Luchtretour		8mm Push-in	41.25

5/3 luchtbediend ventiel - 8mm push-in

VEN		Functie	Lucht	€
1252296001	Ac Lb 5/3 8mm Midden Gesloten Rtc Lucht - Lucht, Return To Centre		8mm Push-in	53.15
1252296002	Ac Lb 5/3 8mm Midden Geopend Rtc Lucht - Lucht, Return To Centre		8mm Push-in	53.15
1252296003	Ac Lb 5/3 8mm Midden Druk Rtc Lucht - Lucht, Return To Centre		8mm Push-in	53.15

Serie 125 - 1/4"



5/2 luchtbediend ventiel - 1/4" BSP female

VEN		Functie	Lucht	€
1252235001	AC LB 5/2 1/4" Veerr Lucht - Veer, Hulplucht		1/4"	34.55
1252235002	AC LB 5/2 1/4" Bistabiel Lucht - Lucht		1/4"	38.40
1252235003	AC LB 5/2 1/4" Differentieel Lucht - Lucht, Luchtretour		1/4"	43.35

5/3 luchtbediend ventiel - 1/4" BSP female

VEN		Functie	Lucht	€
1252236001	AC LB 5/3 1/4" Midden Gesloten RTC Lucht - Lucht, Return To Centre		1/4"	56.35
1252236002	AC LB 5/3 1/4" Midden Geopend RTC Lucht - Lucht, Return To Centre		1/4"	56.35
1252236003	AC LB 5/3 1/4" Midden Druk RTC Lucht - Lucht, Return To Centre		1/4"	56.35

KELM™
pneumatiek

Hydrauliek

Snel-
koppelingen

Afsluiters

Roestvast
staal

Fittingen

Lucht-
conditionering

Gereedschap

Pneumatiek

Diversen

Malleabele
fittingen
& staal

Ringleiding-
systemen

Slangen

Compressoren

Luchtbediende ventielen



Medium:

Gesmeerde of ongesmeerde geconditioneerde perslucht



Temperatuur:

-5°C tot 50°C



3/2 & 5/2: 1000 L/min bij 6 bar /ΔP 1
5/3: 650 L/min (CC), 550 L/min (CA), 500 L/min (CP) bij 6 bar /ΔP 1



Huis: aluminium

Interne delen: messing en RVS

Dichtingen: NBR

Serie 128 - 1/4" - aluminium



Werkdruk: 1 - 10 bar

Stuurdruk bij 1 bar: 1 bar

Stuurdruk bij 10 bar: 4 bar

3/2 luchtbediend ventiel - 1/4" BSP female

VEN	Funcie	Lucht	€
1282233001	AC LB NC 3/2 NC Lucht-Veer, Hulplucht		1/4" 28.95
1282233002	AC LB NO 3/2 NO Lucht-Veer, Hulplucht		1/4" 30.35
1282233003	AC LB 3/2 Bistabiel Lucht-Lucht		1/4" 33.35

5/2 luchtbediend ventiel - 1/4" BSP female

VEN	Funcie	Lucht	€
1282235001	AC LB 5/2 Monostabiel Lucht-Veer, Hulplucht		1/4" 33.35
1282235002	AC LB 5/2 Bistabiel Lucht-Lucht		1/4" 36.85



Tech Data
60398

5/3 luchtbediend ventiel - 1/4" BSP female

VEN	Funcie	Lucht	€
1282236001	AC LB 5/3 Lucht-Lucht / Middenstand gesloten, Return to centre		1/4" 61.40
1282236002	AC LB 5/3 Lucht-Lucht / Middenstand geopend, Return to centre		1/4" 61.40
1282236003	AC LB-128 5/3 Lucht-Lucht / Middenstand onder druk, Return to centre		1/4" 61.40

Elektropneumatische schuifventielen



Type spoel = 22 mm



DC = 3 watt
AC = 5 VA



Temperatuur:

-5°C tot 50°C



3/2 & 5/2: 1000 L/min bij 6 bar /ΔP 1
5/3: 650 L/min (CC), 550 L/min (CA), 500 L/min (CP) bij 6 bar /ΔP 1



Huis: aluminium

Interne delen: messing en RVS

Dichtingen: NBR

Single use en batterijmontage

Serie 128 - 1/4" - aluminium



Werkdruk:

1 - 10 bar

3/2 schuifventiel - 1/4" BSP female - met manual override - zonder spoel en stekker

VEN	Funcie	Lucht	€
1282133001	AC EPV-128 NC 3/2 NC Elek/Pneu-Veer (interne hulplucht)		1/4" 43.90
1282133002	AC EPV-128 NO 3/2 NO Elek/Pneu-Veer (interne hulplucht)		1/4" 45.20
1282133003	AC EPV-128 3/2 Bistabiel Elek/Pneu-Elek/Pneu		1/4" 68.40

5/2 schuifventiel - 1/4" BSP female - met manual override - zonder spoel en stekker

VEN	Funcie	Lucht	€
1282135001	AC EPV-128 5/2 Elek/Pneu-Veer (interne hulplucht)		1/4" 44.75
1282135002	AC EPV-128 5/2 Bistabiel Elek/Pneu-Elek/Pneu		1/4" 70.15



Tech Data
60398

5/3 schuifventiel - 1/4" BSP female - met manual override - zonder spoel en stekker

VEN	Funcie	Lucht	€
1282136001	AC EPV-128 5/3 Elek/Pneu-Elek/Pneu / middenstand gesloten, Return to centre		1/4" 94.80
1282136002	AC EPV-128 5/3 Elek/Pneu-Elek/Pneu / middenstand geopend, Return to centre		1/4" 94.80
1282136003	AC EPV-128 5/3 Elek/Pneu-Elek/Pneu / middenstand onder druk, Return to centre		1/4" 94.80

Elektropneumatische schuifventielen



Isolatie klasse (IP) IP65 **Temperatuur:** -5°C tot 50°C **Type manual override:** Monostabiel

EM120
120 serie = SINGLE USE

mat Huis Kunststof (technopolymeer)
Delen, messing en RVS **SEAL** NBR

FLOW Serie 120: 490 L/min bij 6 bar /ΔP 1
Serie 125: 800 L/min bij 6 bar /ΔP 1

spoel Type spoel = 22 mm **WATT** DC = 3 watt
AC = 5 VA



Serie 120 - 1/8"

Maximale werkdruk:
Werkdruk: Monostabiel: 1 - 10 bar
Bistabiel: 0,5 - 10 bar

3/2 schuifventiel - 1/8" BSP female - met manual override - zonder spoel en stekker

VEN		Functie	Lucht	€
1202123001	AC EPV- 120 3/2 1/8" NC Elek/Pneu - Veer (Interne Hulplucht)			41.70
1202123002	AC EPV-120 3/2 1/8" NO Elek/Pneu - Veer (Interne Hulplucht)			41.70
1202123003	AC EPV-120 3/2 1/8" Elek/Pneu - Elec/pneu			62.60

Maximale werkdruk:
Monostabiel: 1 - 10 bar
Bistabiel: 0 - 10 bar

5/2 schuifventiel - 1/8" BSP female - met manual override - zonder spoel en stekker

VEN		Functie	Lucht	€
1202125001	AC EPV-120 5/2 1/8" VEERR Elek-Pneu - Veer (Interne Hulplucht)			44.85
1202125002	AC EPV-120 5/2 1/8" Elek-Pneu - Elek-Pneu			65.50

5/3 schuifventiel - 1/8" BSP female - met manual override - zonder spoel en stekker

VEN		Functie	Lucht	€
1202126001	AC EPV-120 5/3 1/8" MC - RTC Elek-Pneu - Elek-Pneu / Middenstand Gesloten / Return to Centre			82.30
1202126002	AC EPV-120 5/3 1/8" MO - RTC Elek-Pneu - Elek-Pneu / Middenstand Geopend / Return to Centre			82.30
1202126003	AC EPV-120 5/3 1/8" MD - RTC Elek-Pneu - Elek-Pneu / Middenstand Onder Druk / Return to Centre			82.30

Serie 120 - 1/8" - pilot

Maximale werkdruk:
Werkdruk: 0 - 10 bar
Stuurdruk: Monostabiel: 1 - 10 bar
Bistabiel: 0,5 - 10 bar

3/2 pilot schuifventiel - 1/8" BSP female - met manual override - zonder spoel en stekker

VEN		Functie	Lucht	€
1202123004	AC EPV-120 3/2 1/8" AM5- NC Elek/Pneu / Pilot - Veer (Interne Hulplucht) Aansluiting Pilot: M5			46.65
1202123007	AC EPV-120 3/2 1/8" A4MM-NC Elek/Pneu / Pilot - Veer (Interne Hulplucht) Aansluiting Pilot: 4mm Push-in			47.70
1202123005	AC EPV-120 3/2 1/8" AM5-NO Elek/Pneu / Pilot - Veer (Interne Hulplucht) Aansluiting Pilot: M5			46.65
1202123008	AC EPV-120 3/2 1/8" A4MM-NO Elek/Pneu / Pilot - Veer (Interne Hulplucht) Aansluiting Pilot: 4mm Push-in			47.70
1202123006	AC EPV-120 3/2 1/8" AM5 Elek/Pneu / Pilot - Elek/Pneu / Pilot Aansluiting Pilot: M5			71.05
1202123009	AC EPV-120 3/2 1/8" A4MM Elek/Pneu / Pilot - Elek/Pneu / Pilot Aansluiting Pilot: 4mm Push-in			73.40



KELM™ pneumatiek
Hydrauliek
Snelkoppelingen
Afsluiters
Roestvast staal
Fittingen
Luchtconditionering
Gereedschap
Pneumatiek
Diversen
Malleabele fittingen & staal
Ringleidingssystemen
Slangen
Compressoren

Elektropneumatische schuifventielen



EM120
120 serie = SINGLE USE



Serie 120 - 1/8" - pilot

Maximale werkdruk:
Werkdruk: 0 - 10 bar
Stuurdruk: 5/2: 0,5 - 10 bar. 5/3: 2,1 - 10 bar

5/2 pilot schuifventiel - 1/8" BSP female - met manual override - zonder spoel en stekker

VEN		Functie	Lucht	€
1202125003	AC EPV-120 5/2 1/8" AM5 VEERR Elek-Pneu / Pilot - Veer (Interne Hulplucht) Aansluiting Pilot: M5		1/8"	50.50
1202125005	AC EPV-120 5/2 1/8" A4MM VEERR Elek-Pneu / Pilot - Veer (Interne Hulplucht) Aansluiting Pilot: 4mm Push-in		1/8"	51.40
1202125004	AC EPV-120 5/2 1/8" AM5 Elek-Pneu / Pilot - Elek-Pneu / Pilot Aansluiting Pilot: M5		1/8"	73.40
1202125006	AC EPV-120 5/2 1/8" A4MM Elek-Pneu / Pilot - Elek-Pneu / Pilot Aansluiting Pilot: 4mm Push-in		1/8"	74.90

5/3 pilot schuifventiel - 1/8" BSP female - met manual override - zonder spoel en stekker

VEN		Functie	Lucht	€
1202126004	AC EPV-120 5/3 1/8" AM5 MC - RTC Elek-Pneu / Pilot - Elek-Pneu / Pilot / Middenstand Gesloten/Return to Centre Aansluiting Pilot: M5		1/8"	88.80
1202126007	AC EPV-120 5/3 1/8" A4MM MC - RTC Elek-Pneu / Pilot - Elek-Pneu / Pilot / Middenstand Gesloten/Return to Centre Aansluiting Pilot: 4mm Push-in		1/8"	90.60
1202126005	AC EPV-120 5/3 1/8" AM5 MO - RTC Elek-Pneu / Pilot - Elek-Pneu / Pilot / Middenstand Geopend/Return to Centre Aansluiting Pilot: M5		1/8"	88.80
1202126008	AC EPV-120 5/3 1/8" A4MM MO - RTC Elek-Pneu / Pilot - Elek-Pneu / Pilot / Middenstand Geopend/Return to Centre Aansluiting Pilot: 4mm Push-in		1/8"	90.60
1202126006	AC EPV-120 5/3 1/8" AM5 MD - RTC Elek-Pneu / Pilot - Elek-Pneu / Pilot / Middenstand Druk/Return to Centre Aansluiting Pilot: M5		1/8"	88.80
1202126009	AC EPV-120 5/3 1/8" A4MM MD - RTC Elek-Pneu / Pilot - Elek-Pneu / Pilot / Middenstand Druk/Return to Centre Aansluiting Pilot: 4mm Push-in		1/8"	90.60

EM125
125 serie = SINGLE USE
& BATTERY ASSEMBLY



Serie 125 - 1/4"

Maximale werkdruk:
Werkdruk: 5/2 met veerretour: 1 - 10 bar
5/2 zonder veerretour en 5/3: 0 - 10 bar

5/2 schuifventiel - 1/4" BSP female - met manual override - zonder spoel en stekker

VEN		Functie	Lucht	€
1252135001	AC EPV-125 5/2 1/4" VEERR Elek-Pneu - Veer (Interne Hulplucht)		1/4"	50.50
1252135002	AC EPV-125 5/2 1/4" Elek-Pneu - Elek-Pneu		1/4"	73.40

5/3 schuifventiel - 1/4" BSP female - met manual override - zonder spoel en stekker

VEN		Functie	Lucht	€
1252136001	AC EPV-125 5/3 1/4" MC - RTC Elek-Pneu - Elek-Pneu / Middenstand Gesloten/Return to Centre		1/4"	92.35
1252136002	AC EPV-125 5/3 1/4" MO - RTC Elek-Pneu - Elek-Pneu / Middenstand Geopend/Return to Centre		1/4"	92.35
1252136003	AC EPV-125 5/3 1/4" MD - RTC Elek-Pneu - Elek-Pneu / Middenstand Onder Druk/Return to Centre		1/4"	92.35

Serie 125 - 1/4" - pilot

5/2 pilot schuifventiel - 1/4" BSP female - met manual override - zonder spoel en stekker

VEN		Functie	Lucht	€
1252135003	AC EPV-125 5/2 1/4" ACTM5-VEERR Elek-Pneu / Pilot - Veer (interne hulplucht) Aansluiting Pilot: M5		1/4"	56.70
1252135004	AC EPV-125 5/2 1/4" ACTM5 Elek-Pneu / Pilot - Elek-Pneu / Pilot Aansluiting Pilot: M5		1/4"	81.95

5/3 pilot schuifventiel - 1/4" BSP female - met manual override - zonder spoel en stekker

VEN		Functie	Lucht	€
1252136004	AC EPV-125 5/3 1/4" ACTM5 MC - RTC Elek-Pneu / Pilot - Elek-Pneu / Pilot / Middenstand Gesloten/Return to Centre Aansluiting Pilot: M5		1/4"	99.65
1252136005	AC EPV-125 5/3 1/4" ACTM5 MO - RTC Elek-Pneu / Pilot - Elek-Pneu / Pilot / Middenstand Geopend/Return to Centre Aansluiting Pilot: M5		1/4"	99.65
1252136006	AC EPV-125 5/3 1/4" ACTM5 MD - RTC Elek-Pneu / Pilot - Elek-Pneu / Pilot / Middenstand Druk/Return to Centre Aansluiting Pilot: M5		1/4"	99.65

KELM™ pneumatiek
Hydrauliek
Snel- koppelingen
Afsluiters
Roestvast staal
Fittingen
Lucht- conditionering
Gereedschap
Pneumatiek
Diversen
Malleabele fittingen & staal
Ringleiding- systemen
Slangen
Compressoren

Tech Data 20293

Spoulen en stekkers

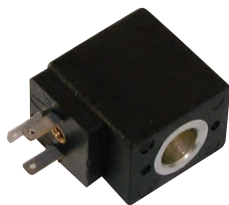

22mm spool - voor ventielen serie 120, 125 en 128

VEN



A502600018	12V DC	6.75
2039-7238	24V DC	6.15
2039-7253	24V/50-60Hz AC	6.15
2039-7279	110V/50-60Hz AC	6.15
2039-7287	220V/50-60Hz AC	6.15
1341A00001	24DC EXPLOSIEVEILIG	70.15



22mm stekker

VEN



2039-7205

1.85

Basisplaat



Basisplaat - voor ventielen serie 125

VEN



2039-6727	AC Basisplaat 125, 2 Posities	17.05
2039-6735	AC Basisplaat 125, 3 Posities	23.45
2039-6743	AC Basisplaat 125, 4 Posities	29.90
2039-6750	AC Basisplaat 125, 5 Posities	36.40
2039-6768	AC Basisplaat 125, 6 Posities	42.80
2039-6776	AC Basisplaat 125, 7 Posities	48.95
2039-6784	AC Basisplaat 125, 8 Posities	55.55
2039-6792	AC Basisplaat 125, 9 Posities	61.95
2039-6800	AC Basisplaat 125, 10 Posities	68.35
2039-7932	AC Blindplaat V Basisplaat 125	1.05

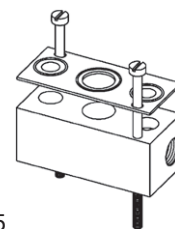

Drukscheidingskit - voor bevestiging van ventielen serie 125 op basisplaat (verschillende werkdrukken)

VEN



1325C00001

28.00

KELM™
pneumatiek

Hydrauliek

Snel-
koppelingen

Afsluiters

Roestvast
staal

Fittingen

Lucht-
conditionering

Gereedschap

Pneumatiek

Diversen

Malleabele
fittingen
& staal

Ringleiding-
systemen

Slangen

Compressoren

Vacuümzuignappen

Zuignappen worden in een breed toepassingsgebied ingezet voor het verplaatsen van goederen.

Geschikt voor verscheidene handlingwerkzaamheden, het openen van zakken, het plaatsen, verplaatsen of vasthouden van componenten en etikettering.

- Verkrijgbaar in NBR & siliconen
- Diameters van 2mm tot 125mm



Vlakzuignap - NBR

0421	DIA ZUG-OPPERVLAK	DIA mm	H mm	Aansluiting mm	€
KC-ZP02UN	2	2,6	12	1,2	3.50
KC-ZP08UN	8	9	12	2,5	4.10
KC-ZP10UN	10	12	12	5	4.40
KC-ZP13UN	13	15	12	5	4.55
KC-ZP16UN	16	18	12,5	5	4.55
KC-ZP20UN	20	23	14	5	4.85
KC-ZP25UN	25	28	14	5	5.65
KC-ZP32UN	32	35	14,5	5	4.40
KC-ZP40UN	40	43	18,5	7	8.85
KC-ZP50UN	50	53	19,5	7	8.85



Vlakzuignap met nokken - NBR

0421	DIA ZUG-OPPERVLAK	DIA mm	H mm	Aansluiting mm	€
KC-ZP10CN	10	12	12	4	5.95
KC-ZP13CN	13	15	12	4	5.55
KC-ZP20CN	20	23	14	4	6.40
KC-ZP32CN	32	35	14,5	4	6.25
KC-ZP40CN	40	43	18,5	7	7.85
KC-ZP50CN	50	53	19,5	7	9.20



Balgzuignap 1,5-voudig - NBR

0421	DIA ZUG-OPPERVLAK	DIA mm	H mm	Aansluiting mm	€
KC-ZP06BN	6	7	13	2,5	5.55
KC-ZP08BN	8	9	13	2,5	5.80
KC-ZP10BN	10	12	16	4	7.25
KC-ZP13BN	13	15	18,5	4	7.30
KC-ZP16BN	16	18	20	4	6.10
KC-ZP20BN	20	23	23,5	4	7.50
KC-ZP25BN	25	28	24	4	6.25
KC-ZP32BN	32	35	29	4	9.65
KC-ZP40BN	40	43	34	7	8.00
KC-ZP50BN	50	53	38	7	9.70

Vlakzuignap - siliconen

0421	DIA ZUG-OPPERVLAK	DIA mm	H mm	Aansluiting mm	€
KC-ZP02US	2	2,6	12	1,2	3.55
KC-ZP04US	4	4,8	12	1,6	4.15
KC-ZP06US	6	7	12	2,5	3.55
KC-ZP08US	8	9	12	2,5	3.95
KC-ZP10US	10	12	12	5	4.55
KC-ZP13US	13	15	12	5	4.55
KC-ZP16US	16	18	12,5	5	4.55
KC-ZP20US	20	23	14	5	4.55
KC-ZP25US	25	28	14	5	5.65
KC-ZP32US	32	35	14,5	5	5.65
KC-ZP40US	40	43	18,5	7	7.05
KC-ZP50US	50	53	19,5	7	7.05

Vlakzuignap met nokken - siliconen

0421	DIA ZUG-OPPERVLAK	DIA mm	H mm	Aansluiting mm	€
KC-ZP10CS	10	12	12	4	5.55
KC-ZP16CS	16	18	12,5	4	5.55
KC-ZP20CS	20	23	14	4	5.55
KC-ZP25CS	25	28	14	4	5.80
KC-ZP50CS	50	53	19,5	7	7.85



Balgzuignap 1,5-voudig - siliconen

0421	DIA ZUG-OPPERVLAK	DIA mm	H mm	Aansluiting mm	€
KC-ZP08BS	8	9	13	2,5	5.95
KC-ZP10BS	10	12	16	4	6.75
KC-ZP13BS	13	15	18,5	4	7.30
KC-ZP16BS	16	18	20	4	7.25
KC-ZP20BS	20	23	23,5	4	6.75
KC-ZP25BS	25	28	24	4	6.35
KC-ZP32BS	32	35	29	4	7.70
KC-ZP40BS	40	43	34	7	7.85
KC-ZP50BS	50	53	38	7	7.55

Diepe zuignap - NBR

0421	DIA ZUG-OPPERVLAK	DIA mm	H mm	Aansluiting mm	€
KC-ZP25DN	25	28	20	4	6.25
KC-ZP40DN	40	43	29	7	7.85

Diepe zuignap - siliconen

0421	DIA ZUG-OPPERVLAK	DIA mm	H mm	Aansluiting mm	€
KC-ZP25DS	25	28	20	4	6.25
KC-ZP40DS	40	43	29	7	7.85

Voor...



PU Ester slang



...zie pagina 77

Voor...



Zuignap adapters



...zie pagina 650

Heavy Duty zuignappen

Zuignappen worden in een breed toepassingsgebied ingezet voor het verplaatsen van goederen.

Geschikt voor diverse handlungswerkzaamheden, het openen van zakken, het plaatsen, verplaatsen of vasthouden van componenten en etikettering.

- Verkrijgbaar in NBR & siliconen
- Diameters van 40mm tot 125mm

Vlakzuignap met nokken - NBR



0421	DIA ZUG-OPPERVLAK	DIA mm	H mm	€
KC-ZP40HN	40	42	11.5	16.35
KC-ZP50HN	50	52	11.5	18.05
KC-ZP63HN	63	65	14.5	22.35
KC-ZP80HN	80	82	16.5	27.45
KC-ZP100HN	100	103	21	34.40
KC-ZP125HN	125	128	21	39.00

Balgzuignap 1,5-voudig - NBR



0421	DIA ZUG-OPPERVLAK	DIA mm	H mm	€
KC-ZP40HBN	40	41.4	20.5	21.45
KC-ZP63HBN	63	65.1	31.5	30.70
KC-ZP100HBN	100	103.1	47.5	38.65
KC-ZP125HBN	125	128.5	56	49.35

Vlakzuignap met nokken - siliconen



0421	DIA ZUG-OPPERVLAK	DIA mm	H mm	€
KC-ZP50HS	50	52	11.5	18.05
KC-ZP63HS	63	65	14.5	22.35
KC-ZP125HS	125	128	21	38.65

Balgzuignap 1,5-voudig - siliconen



0421	DIA ZUG-OPPERVLAK	DIA mm	H mm	€
KC-ZP40HBS	40	41.4	20.5	21.45
KC-ZP50HBS	50	51.9	24	23.55
KC-ZP80HBS	80	83	38	32.60
KC-ZP100HBS	100	103.1	47.5	38.65
KC-ZP125HBS	125	128.5	56	49.35

Hefkracht vacuüm zuignappen

De theoretische hefkracht van een zuignap kan vastgesteld worden met behulp van onderstaande tabel

Berekening

- W Hefkracht (N)
 P Vacuümdruk (kPa)
 S Diameter zuignap(cm²)
 T Veiligheidsfactor - horizontaal heffen: 4 en verticaal heffen: 8

De theoretische hefkracht (zonder veiligheidsfactor) wordt bepaald door de afmeting van de zuignap en onderdruk (vacuüm). De benodigde hefkracht wordt berekend via onderstaande formule:

Praktische hefkracht = theoretische hefkracht ÷ veiligheidsfactor

Diameter zuignap (mm)	ø2	ø4	ø6	ø8	ø10	ø13	ø16	ø20	ø25	ø32	ø40	ø50	ø63	ø80	ø100	ø125	
Oppervlakte zuignap (cm ²)	0.031	0.126	0.283	0.503	0.875	1.330	2.010	3.140	4.910	8.04	12.60	19.60	31.20	50.20	78.50	122.70	
"Vacuümdruk (kPa)"	-85	0.264	1.070	2.41	4.28	6.67	11.30	17.10	26.70	41.70	68.30	107.00	167.00	265.00	427.00	667.00	1043.00
	-80	0.248	1.010	2.26	4.20	6.28	10.60	16.10	25.10	39.30	64.30	101.00	157.00	250.00	402.00	628.00	982.00
	-75	0.233	0.945	2.12	3.77	5.89	9.98	15.10	23.60	36.80	60.30	94.50	147.00	234.00	377.00	589.00	920.00
	-70	0.217	0.882	1.98	3.52	5.50	9.31	14.10	22.00	34.40	56.30	88.20	137.00	218.00	351.00	550.00	859.00
	-65	0.202	0.819	1.84	3.27	5.10	8.65	13.10	20.40	31.90	52.30	81.90	127.00	203.00	326.00	510.00	798.00
	-60	0.186	0.756	1.70	3.02	4.71	7.98	12.10	18.80	29.50	48.20	75.60	118.00	187.00	301.00	471.00	736.00
	-55	0.171	0.693	1.56	2.77	4.32	7.32	11.10	17.30	27.00	44.20	69.30	108.00	172.00	276.00	432.00	675.00
	-50	0.155	0.630	1.42	2.52	3.93	6.65	10.10	15.70	24.60	40.20	63.00	98.00	156.00	251.00	393.00	614.00
	-45	0.140	0.567	1.27	2.26	3.53	5.99	9.05	14.10	22.10	36.20	56.70	88.20	140.00	226.00	353.00	552.00
	-40	0.124	0.504	1.13	2.01	3.14	5.32	8.04	12.60	19.60	32.20	50.40	78.40	125.00	201.00	314.00	491.00

- KELM™ pneumatiek
- Hydrauliek
- Snelkoppelingen
- Afsluiters
- Roestvast staal
- Fittingen
- Luchtconditionering
- Gereedschap
- Pneumatiek
- Diversen
- Malleabele fittingen & staal
- Ringleidingssystemen
- Slangen
- Compressoren

Zuignap adapters

Tech Data
10697



Metrisch male

0421		Aansluiting mm	T.b.v. zuig-diameter mm	€
KC-ZPT1-A5	M5 x 0.8	1.7	Ø 2/8	1.85
KC-ZPT1-A6	M6 x 1.0	1.7	Ø 2/8	1.75

Tech Data
10697



Metrisch male verlengd

0421		Aansluiting mm	T.b.v. zuig-diameter mm	€
KC-ZPT2-A5	M5 x 0.8	2.5	Ø 10/16	3.95
KC-ZPT2-A6	M6 x 1.0	2.5	Ø 10/16	3.95
KC-ZPT3-A6	M6 x 1.0	3.5	Ø 20/32	3.95
KC-ZPT3-A8	M8 x 1.0	3.5	Ø 20/32	3.95
KC-ZPT4-A6	M6 x 1.0	3.5	Ø 40/50	6.85
KC-ZPT4-A8	M8 x 1.0	4.5	Ø 40/50	6.85

Tech Data
10697



Metrisch/BSP female

0421		Aansluiting mm	T.b.v. zuig-diameter mm	€
KC-ZPT2-B01	1/8"	2.5	Ø 10/16	3.80
KC-ZPT3-B5	M5 x 0.8	2.5	Ø 20/32	3.50
KC-ZPT3-B6	M6 x 1.0	2.5	Ø 20/32	3.50
KC-ZPT3-B01	1/8"	3.5	Ø 20/32	4.40
KC-ZPT4-B01	1/8"	6.8	Ø 40/50	5.90

Tech Data
10699



Metrisch female

0421		Aansluiting mm	T.b.v. zuig-diameter mm	€
KC-ZPT1-B10	M10 x 1.5	6	Ø 40/50	5.20
KC-ZPT2-B8	M8 x 1.25	8	Ø 63/80	7.70
KC-ZPT2-B16	M16 x 1.5	8	Ø 63/80	7.70
KC-ZPT3-B16	M16 x 1.5	10	Ø 100/125	9.45